

S12-0004 Location Map

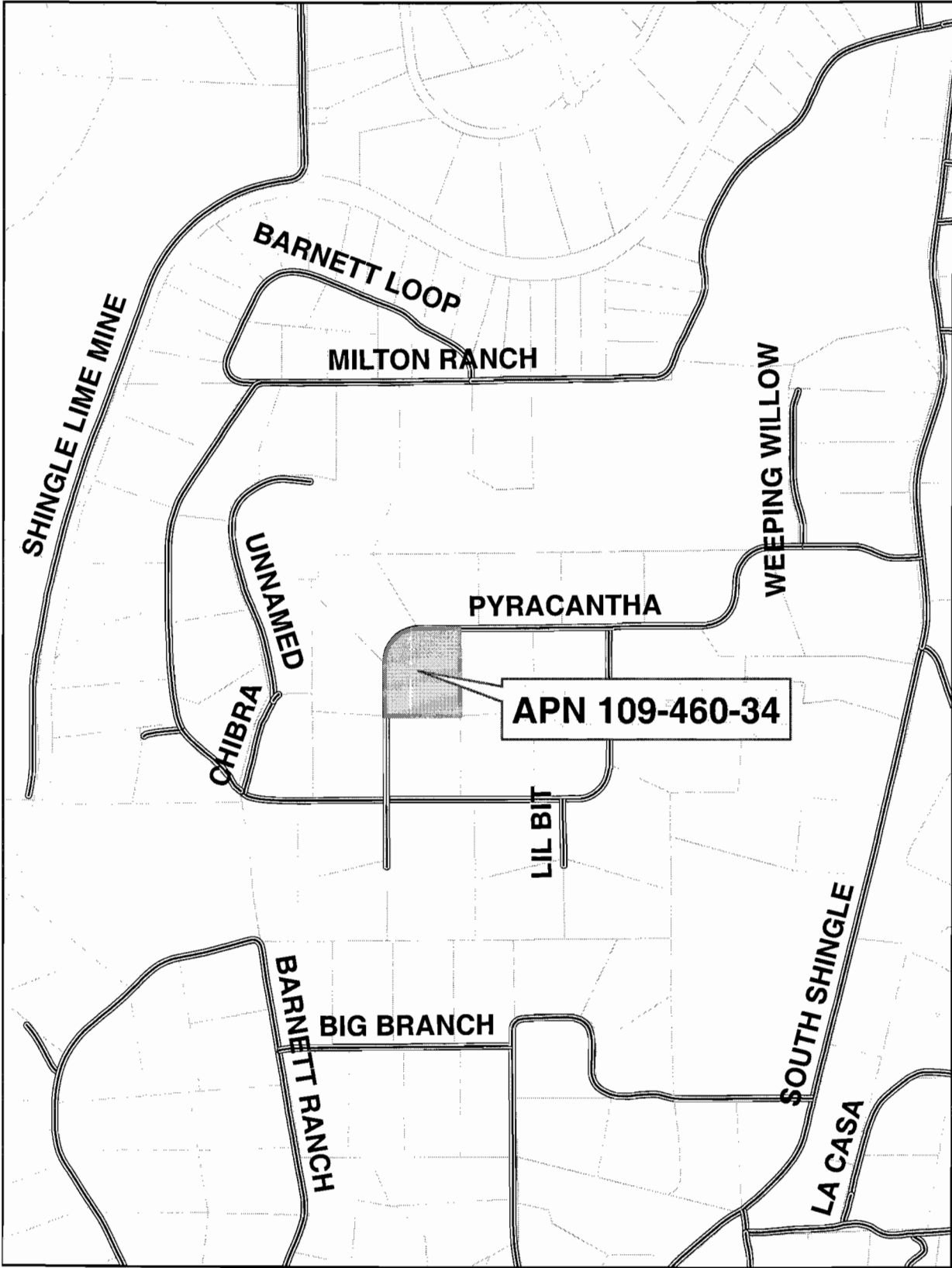
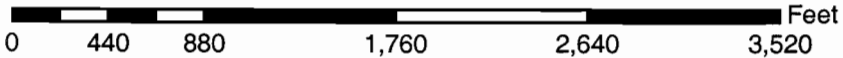
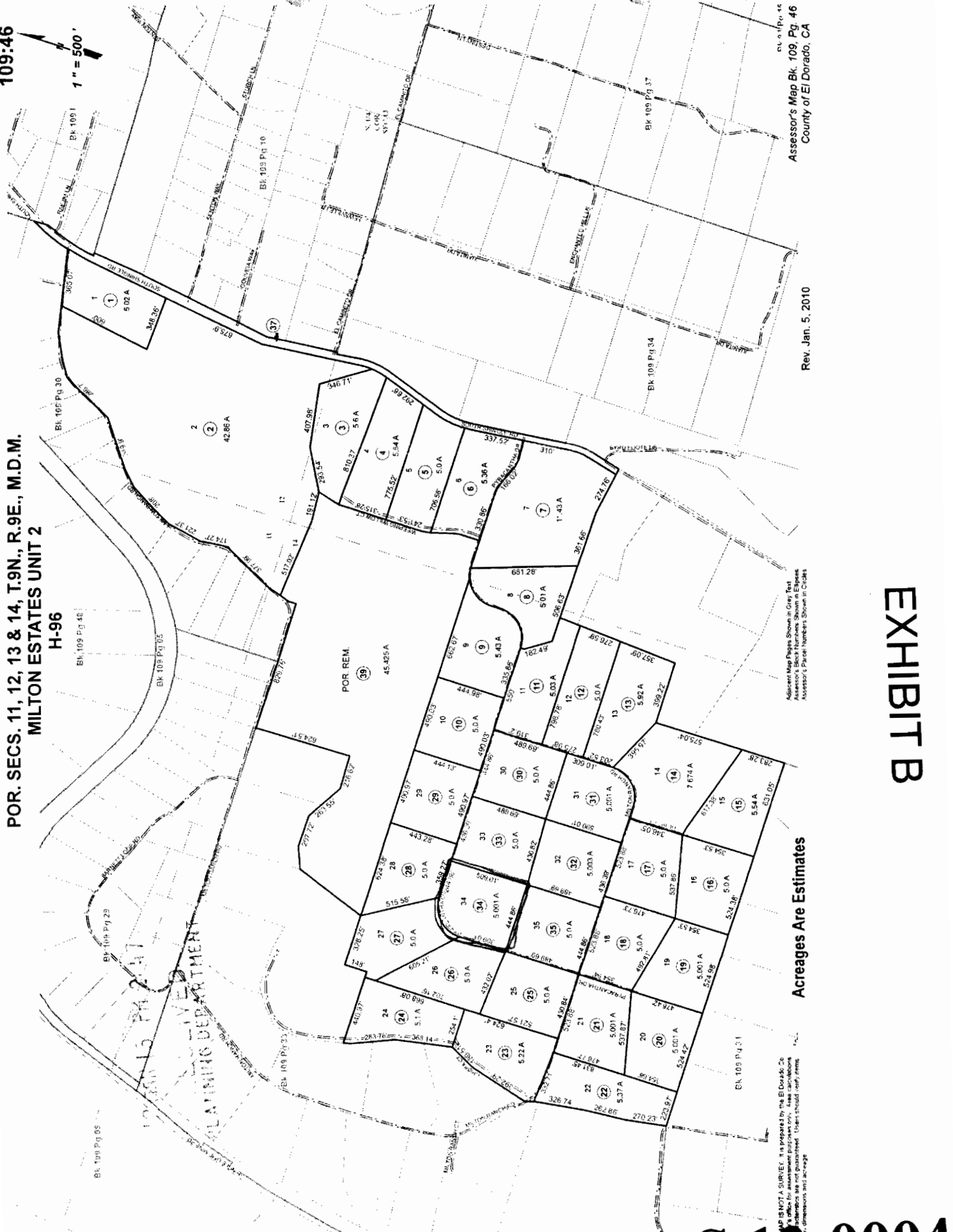

EXHIBIT A



109:46

POR. SECS. 11, 12, 13 & 14, T.9N., R.9E., M.D.M.
MILTON ESTATES UNIT 2
H-96



BK 109 Pg 46

BK 109 Pg 05

BK 109 Pg 29

BK 109 Pg 30

BK 109 Pg 37

BK 109 Pg 34

BK 109 Pg 31

BK 109 Pg 05

THIS MAP IS NOT A SURVEY. It is prepared by the El Dorado County Assessor's Office. The boundaries shown are not guaranteed. Users should verify them by their own measurements and acreage.

Address Map Pages Show in City Text Assessor's Block Numbers Shown in Ellipses Assessor's Parcel Numbers Shown in Circles

Rev. Jan. 5, 2010
Assessor's Map Bk. 109, Pg. 46
County of El Dorado, CA

Acreages Are Estimates

EXHIBIT B

S 12-0004

S12-0004 General Plan Land Use Designation

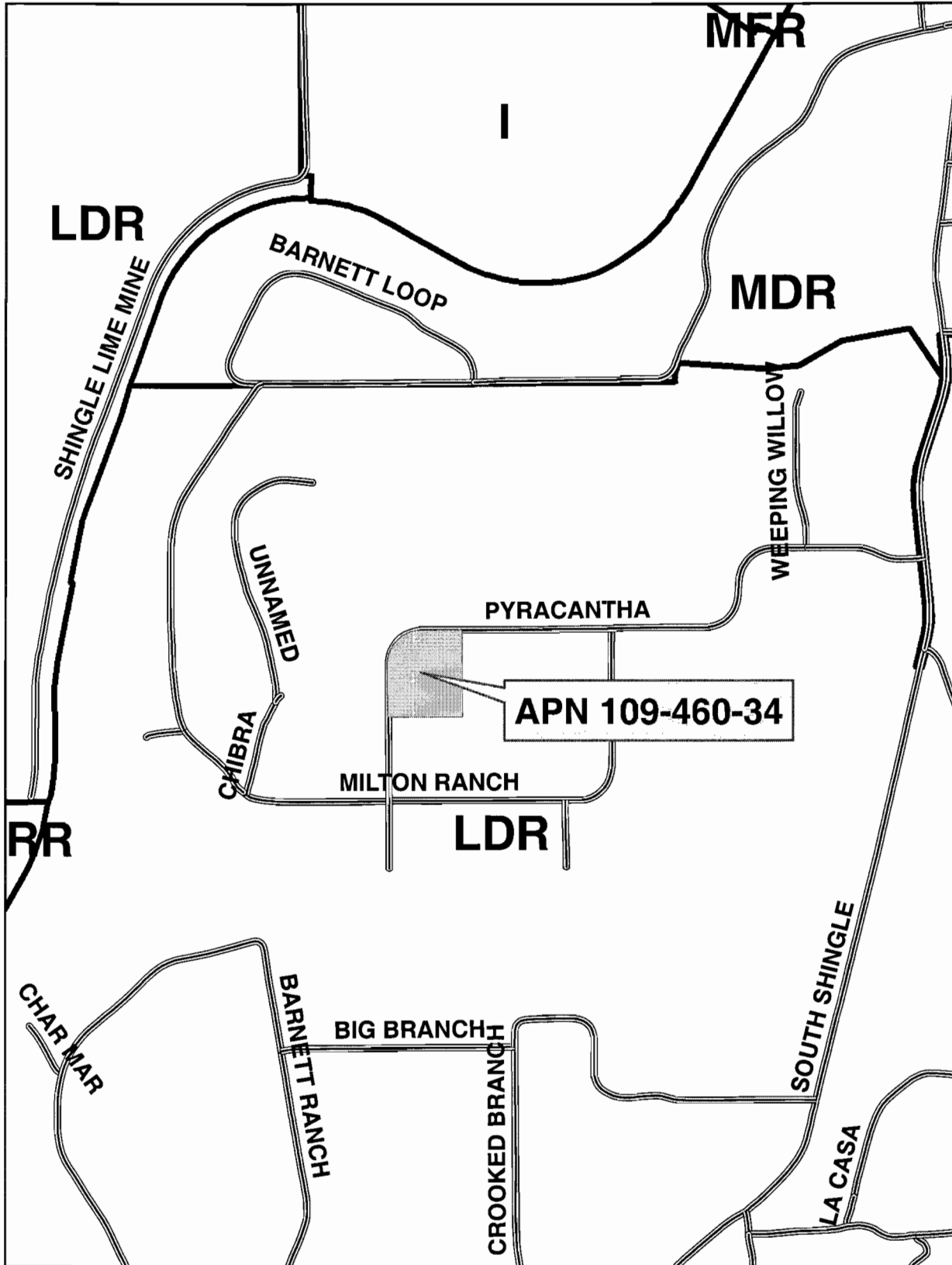
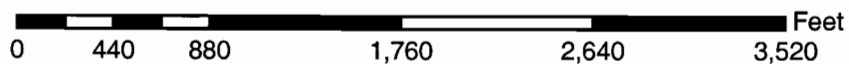

EXHIBIT C



S12-0004 Zoning Map

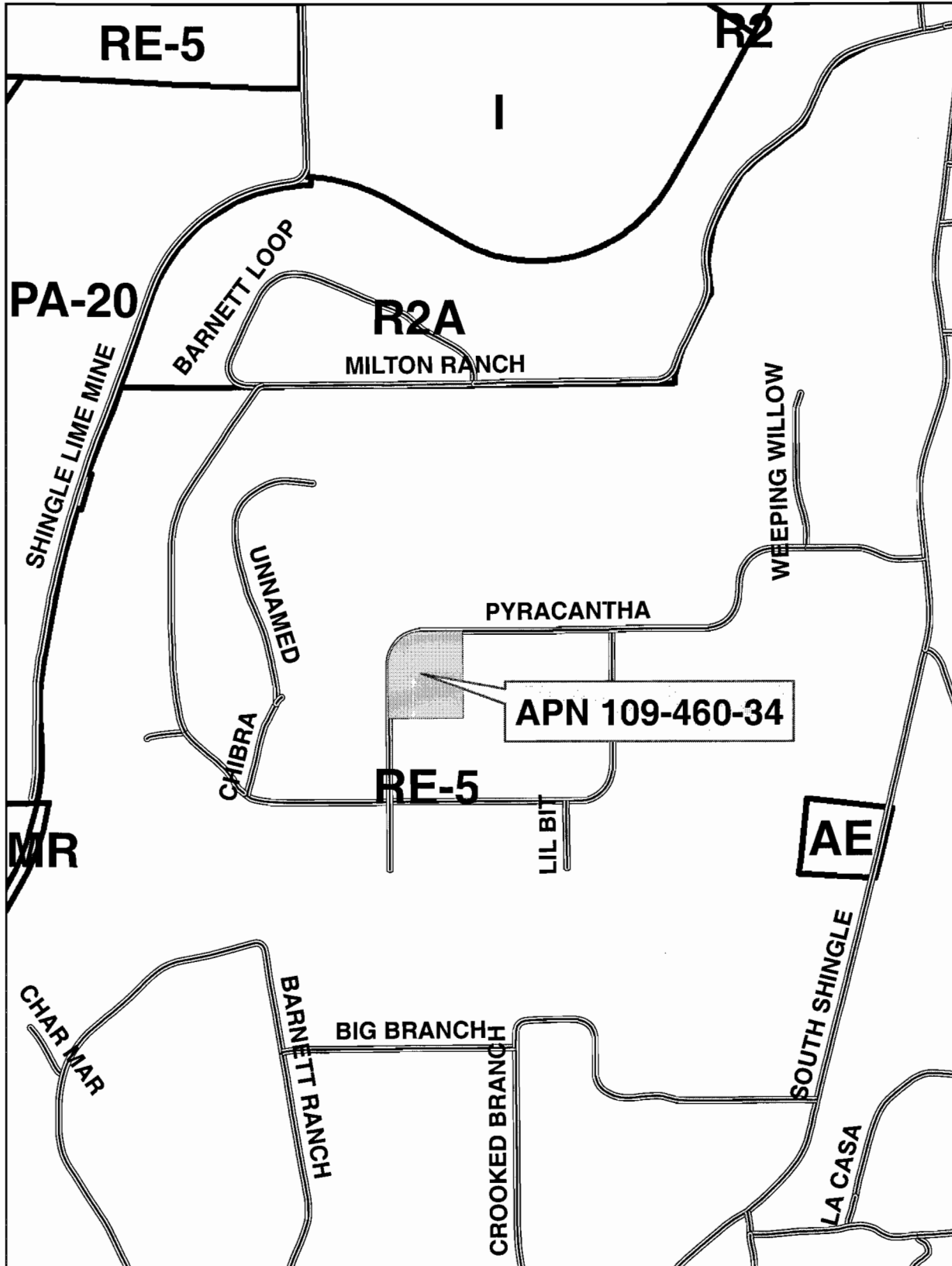
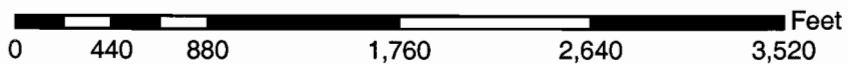

EXHIBIT D



DRIVE

PYRACANTHA

0" FIRE HYDRANT

SEPTIC FIELD

DRIVEWAY

DRIVEWAY

PROPANE TANK

APPROX 80'

PROPOSED KITCHEN

FENCE

50'



SCALE 1"=30'

PARCEL NO. 109-460-34-100

← 446' →

LINDERS FANCY TOFFEE KITCHEN

DON & LINDA FULLER
5570 PYRACANTHA DR
SHINGLE SPRINGS, CA

MARCH 10, 2012

S 12-0004

EXHIBITE

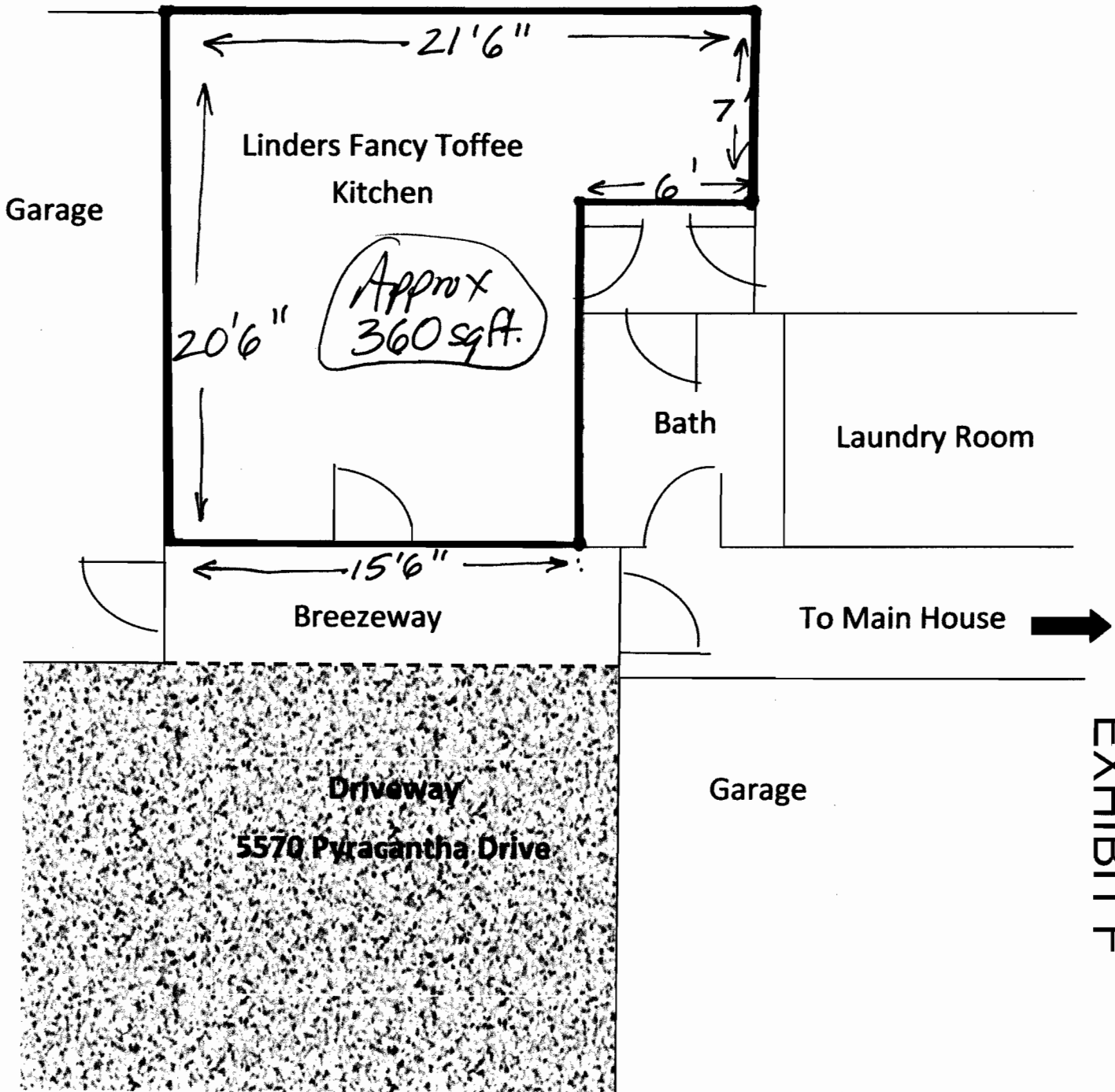

EXHIBIT F



RECEIVED
 PLANNING DEPARTMENT
 12 MAR 15 PM 2:51

S 12-0004



SAVAGE
BROS. CO.
SINCE 1855

1125 Lunt Avenue
Elk Grove Village, IL 60007-5023 USA

Phone: 847-981-3000
USA Fax: 800-2-SAVAGE
World Fax: +847-981-3010

E-mail: info@savagebros.com
Web: www.savagebros.com

A 21st Century Company... with 19th Century Craftsmanship

Electric Table-top FireMixer-14 Cooker-Mixer Cooking System

With PLC Touch-Screen Temperature & Function Control and Water Cooling Feature!

NEW 'SMART' PLC Touch-Screen control panel makes monitoring and controlling your processing easy and fun! Ability to monitor and control temperature of both product AND skin of kettle for no-burn processing. Unique cooling feature permits flushing of heat out of cooker at the end of the cook by flowing tap water through it, giving you time to remove the product without temperature overshoot.

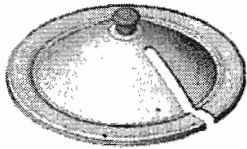

STANDARD LID, Which comes with the FM-14

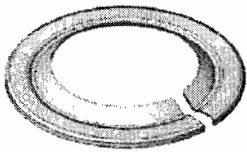

SPLASH LID

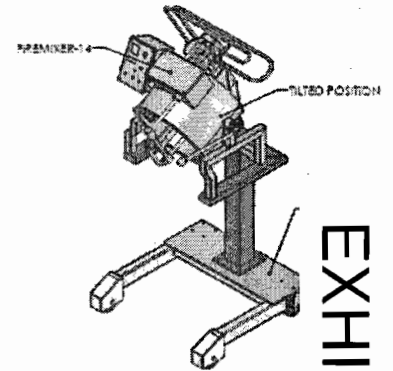
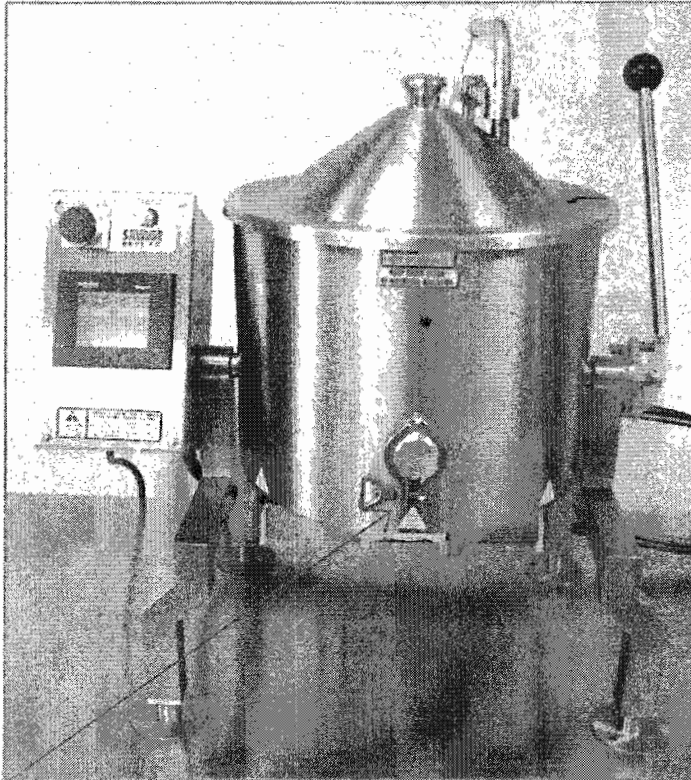

FM-14 ON MOBILE BA
Reaches over table to pour and roll away from table when

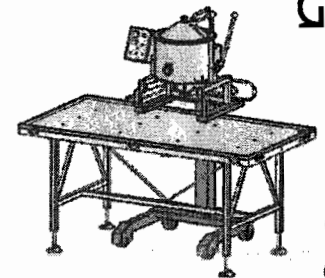
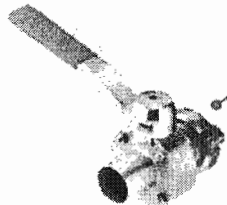
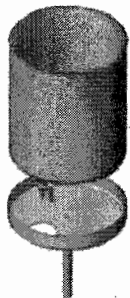

EXHIBIT G

4000-21 S



SANITARY PRODUCT DISPENSING VALVE
For focused controlled dispensing rather than rapid tilting to pour batch- attaches to front port



CREAM CAN ASSEMBLY
To drip-feed condensed milk or other liquids into batch at a controlled rate

Description and Prices for pictured system:

2410 FM-14 Table-Top Cooker \$7,385.00

Upgrades and Options:

Cream Can Assembly	# 2400-05-500	\$ 290.00
Splash Lid- Open Center	# 2400-01-101	\$ 195.00
Sanitary Valve	# 0900-01-214	\$ 345.00
Nut Plow Agitator/Mixer	# 2400-10-160	\$ 385.00
Mobile Base on Casters	# 2400-01-200	\$ 950.00
PC Connectivity Dataport	# 2400-11-200	\$ 340.00

Depositing Pumps also available
Prices Current as of October 2010

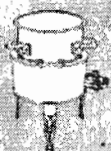

Gas & Electric Stoves • Copper & Stainless Kettles • FireMixer • Cooker-Mixers • Conical Lids • Bowls & Kettles w/ Oil Trucks • Cooking Tablets • Chocolate Tempering • Depositing & Transfer Systems