

ORIGINAL SCALE IS IN INCHES  
 Drawing name: C:\Civil\_3D\Projects\97005-SMUD Trail TAM to SILVA\CADD Files\Production Drawings\SECTIONS.dwg Layout Tab: X-1 Nov 09, 2012 - 11:54am DFriedstad  
 FOR REDUCED PLANS  
 REVISION  
 NUMBER DATE DESCRIPTION BY

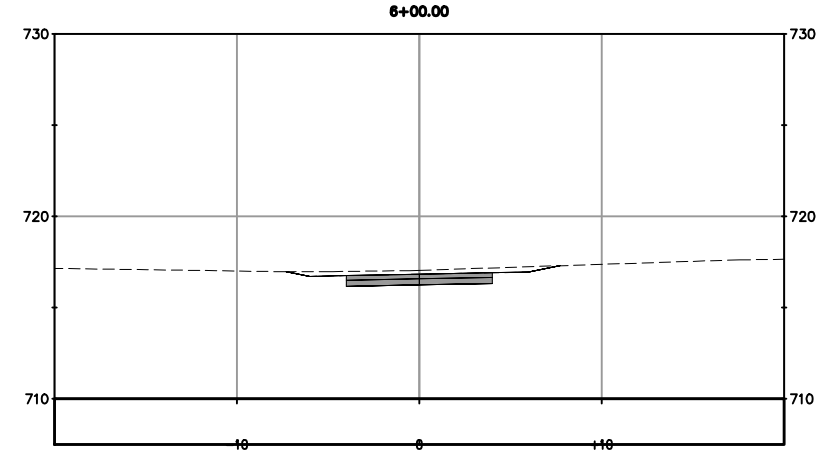
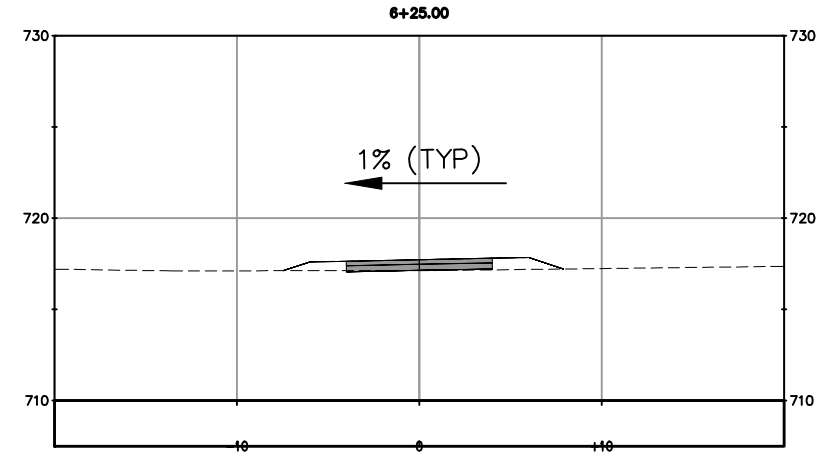
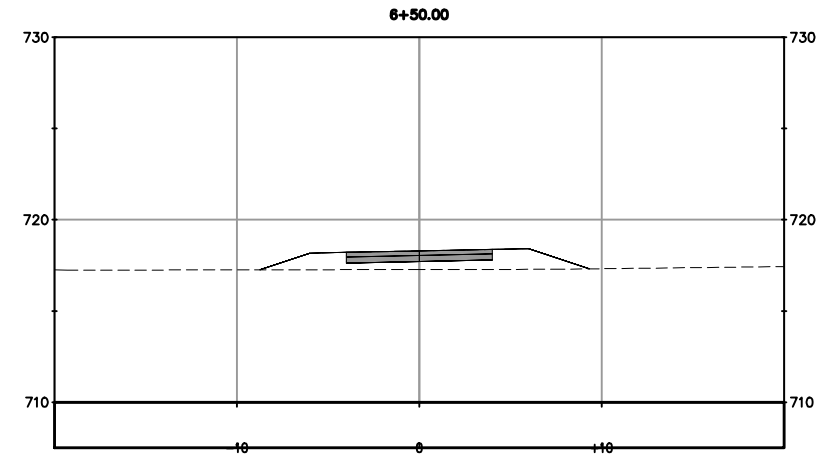
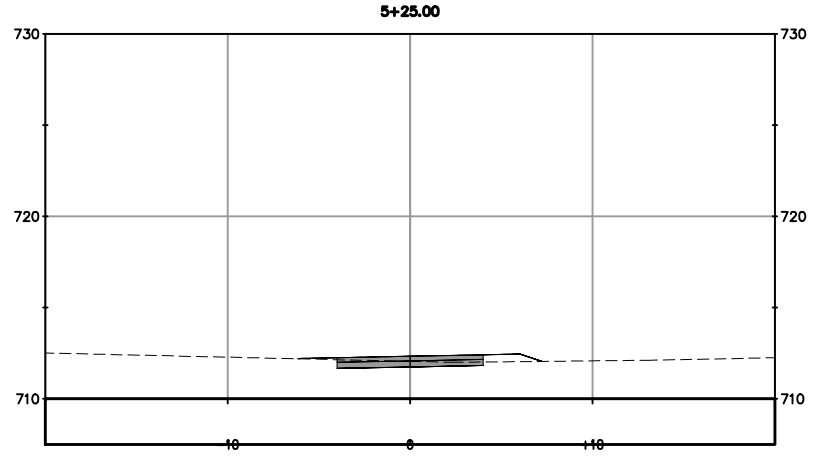
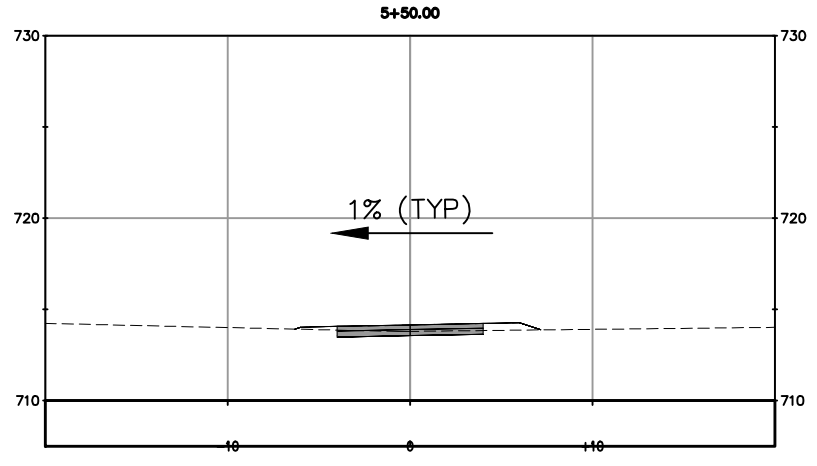
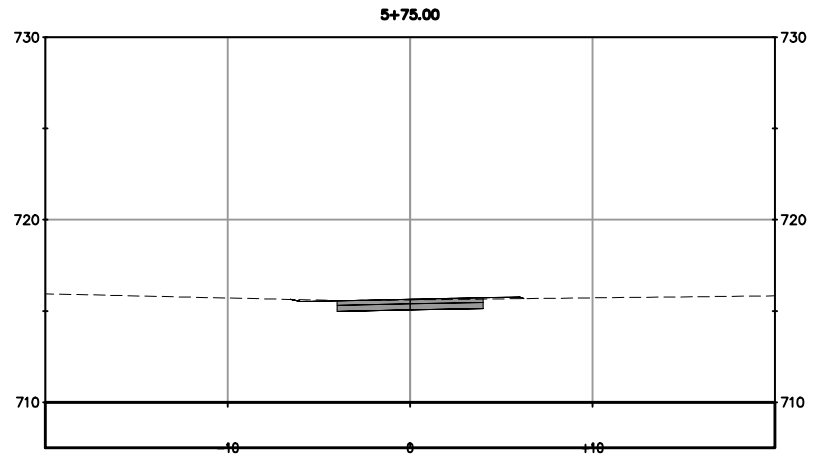
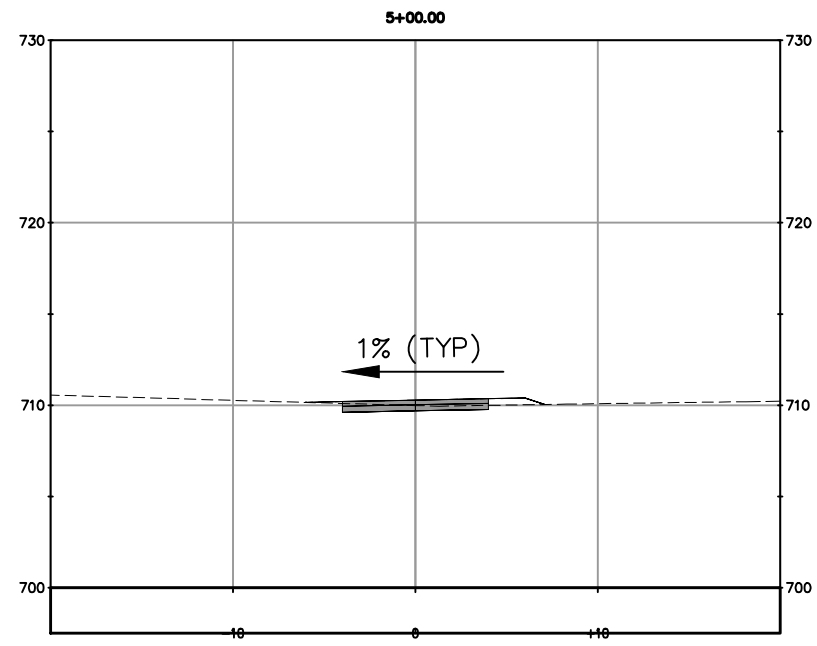
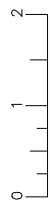

**BIKE TRAIL SECTIONS**  
SCALE: 1" = 10' H&V

**CROSS SECTIONS**  
SCALE: 1" = 10'

NUMBER	DATE	DESCRIPTION	BY

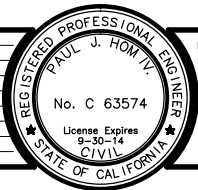

PREPARED UNDER THE SUPERVISION OF :  
 REGISTERED CIVIL ENGINEER  
 DATE:

DESIGNED: DRF  
 DRAWN: DRF  
 CHECKED: PH  
 DATE: 11/09/2012  
 ROAD NUMBER:



**EL DORADO COUNTY**  
**DEPARTMENT OF TRANSPORTATION**

**NEW YORK CREEK TRAIL (EAST)**  
**PHASE 1**

SHEET  
**X-1**  
 1 OF 6  
 W.O. No. **97005**

ORIGINAL SCALE IS IN INCHES  
 Drawing name: C:\Civil\_3D\Projects\97005-SMUD Trail TAM to SILVA\CADD Files\Production Drawings\SECTIONS.dwg Layout Tab: X-2 Nov 09, 2012 - 11:54am DFriedstad  
 FOR REDUCED PLANS  
 REVISION  
 NUMBER DATE DESCRIPTION BY

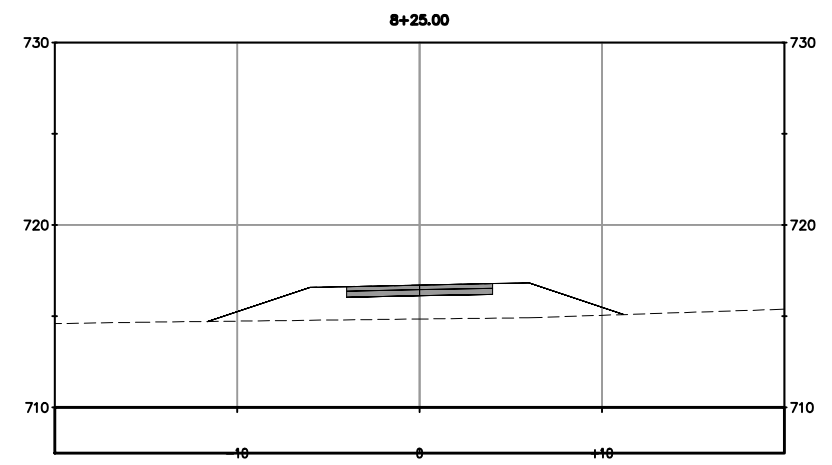
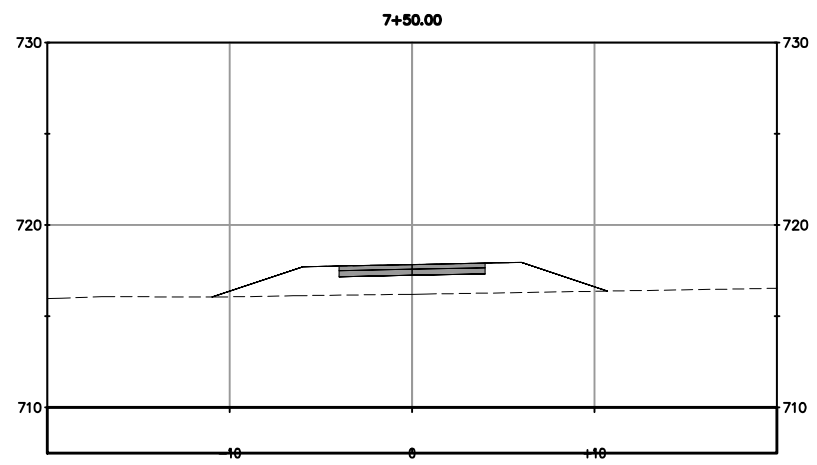
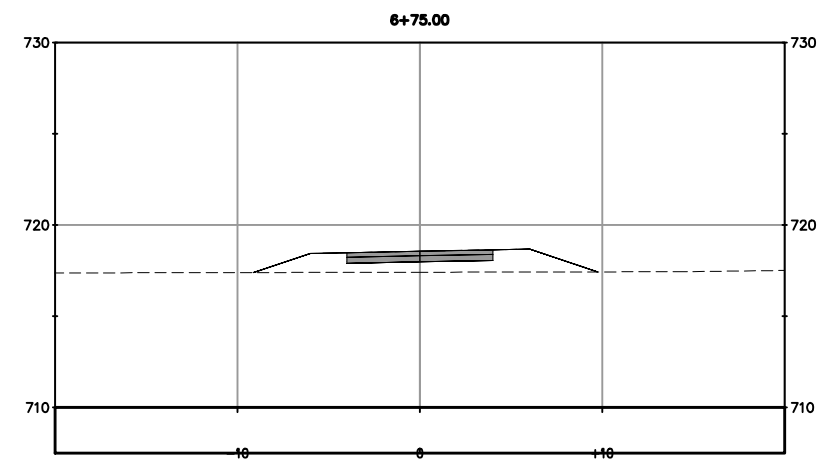
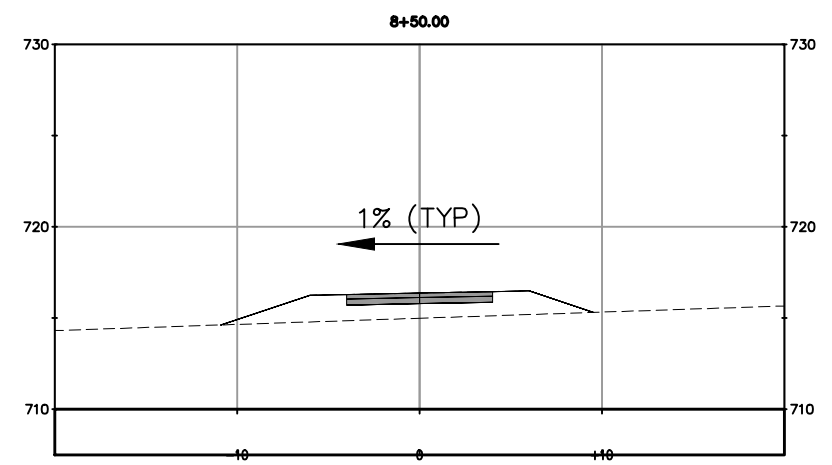
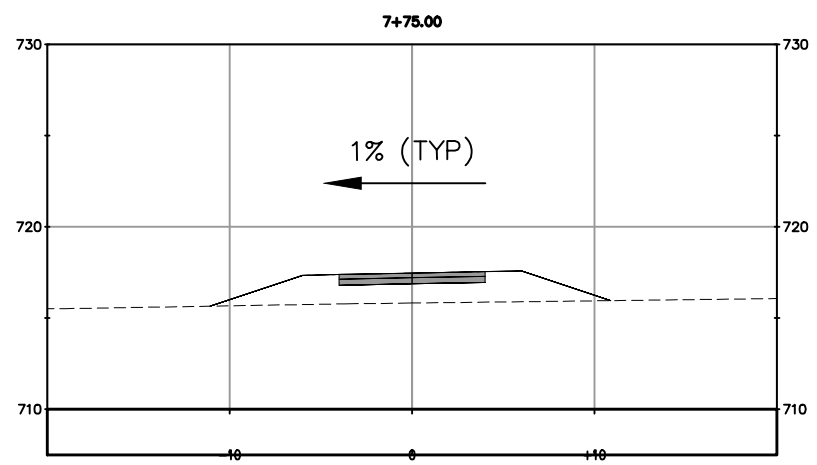
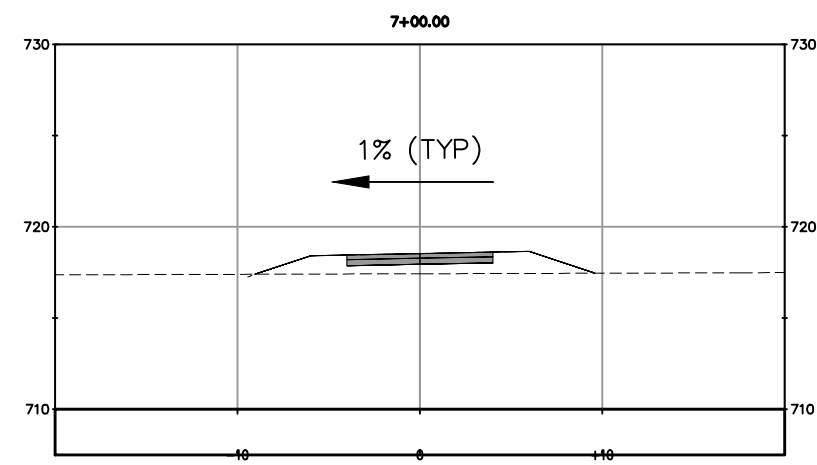
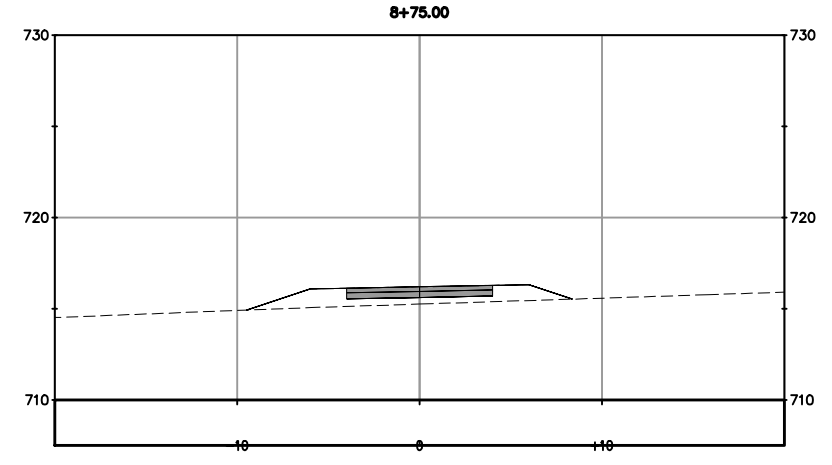
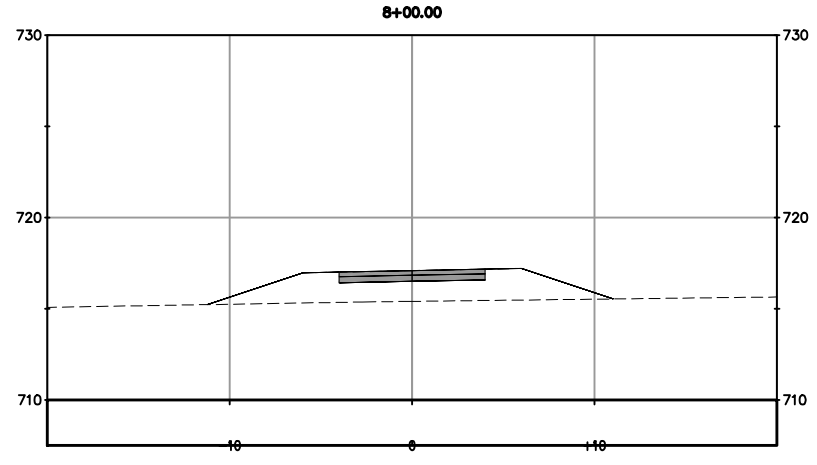
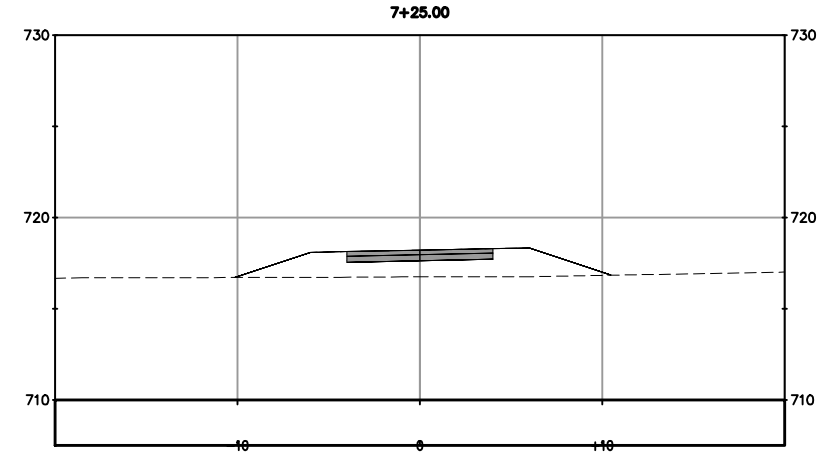

**BIKE TRAIL SECTIONS**  
SCALE: 1" = 10' H&V

**CROSS SECTIONS**  
SCALE : 1" = 10'



PREPARED UNDER THE SUPERVISION OF :  
 REGISTERED CIVIL ENGINEER  
 DATE:

DESIGNED: DRF	DRAWN: DRF
CHECKED: PH	DATE: 11/09/2012
ROAD NUMBER:	



**EL DORADO COUNTY**  
**DEPARTMENT OF TRANSPORTATION**

**NEW YORK CREEK TRAIL (EAST)**  
**phase 1**

SHEET  
**X-2**  
2 OF 6  
W.O. No. **97005**

ORIGINAL SCALE IS IN INCHES  
 Drawing name: C:\Civil\_3D\Projects\97005-SMUD Trail TAM to SILVA\CADD Files\Production Drawings\SECTIONS.dwg Layout Tab: X-3 Nov 09, 2012 - 11:55am DFriedstad  
 FOR REDUCED PLANS  
 REVISION  
 NUMBER DATE DESCRIPTION BY

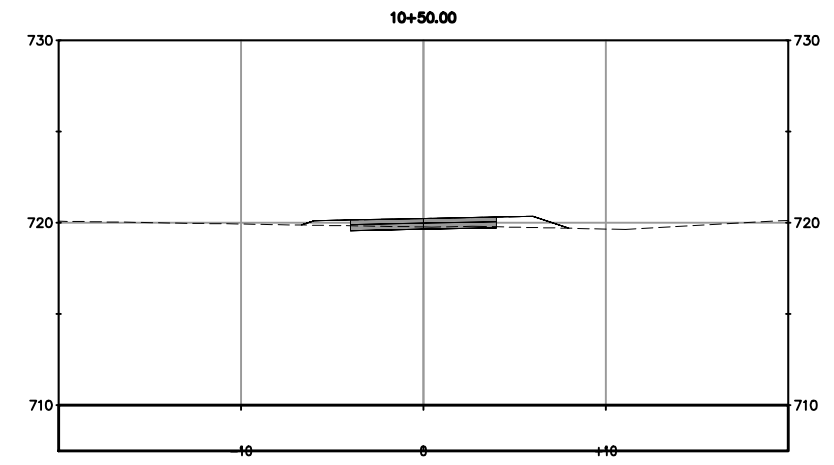
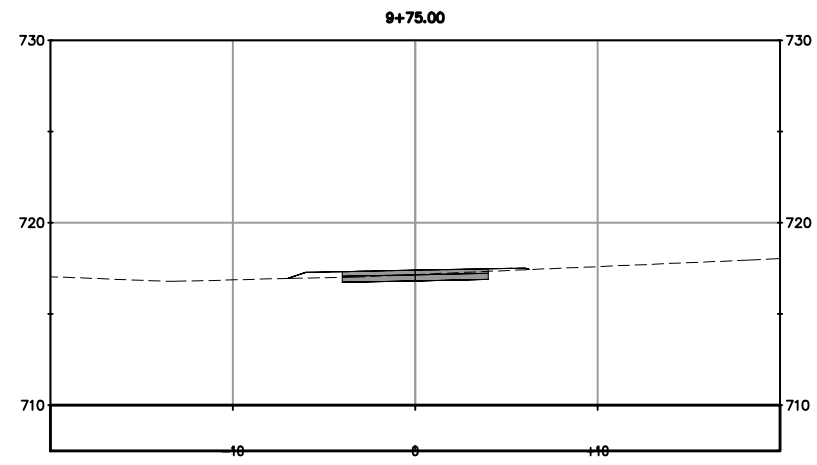
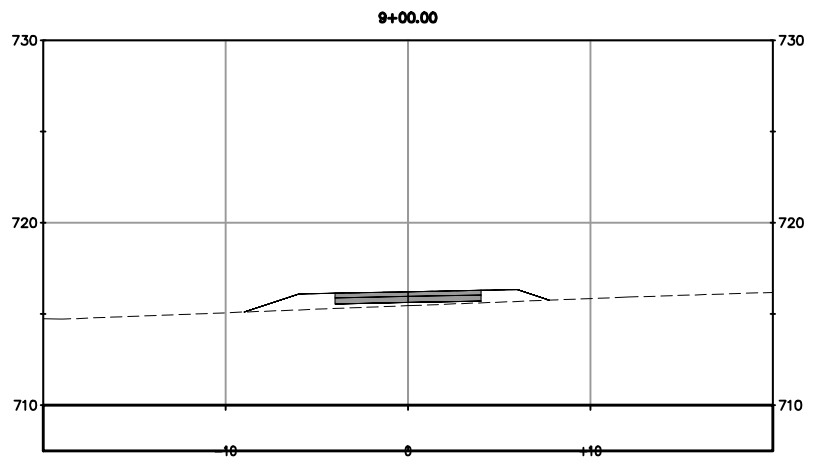
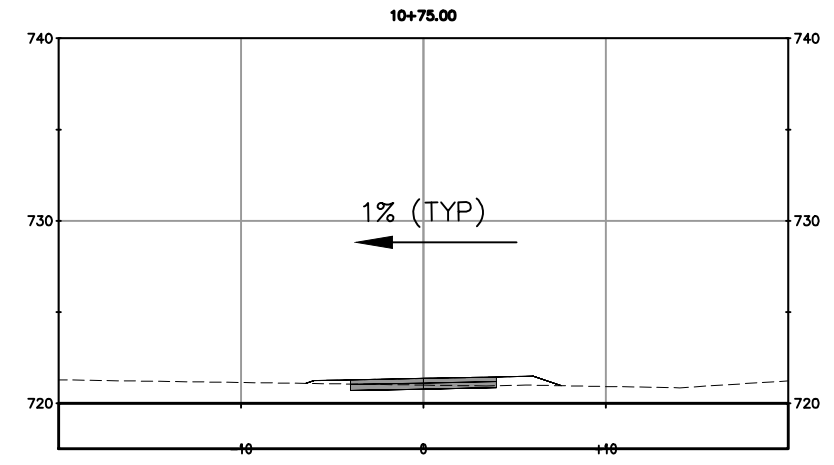
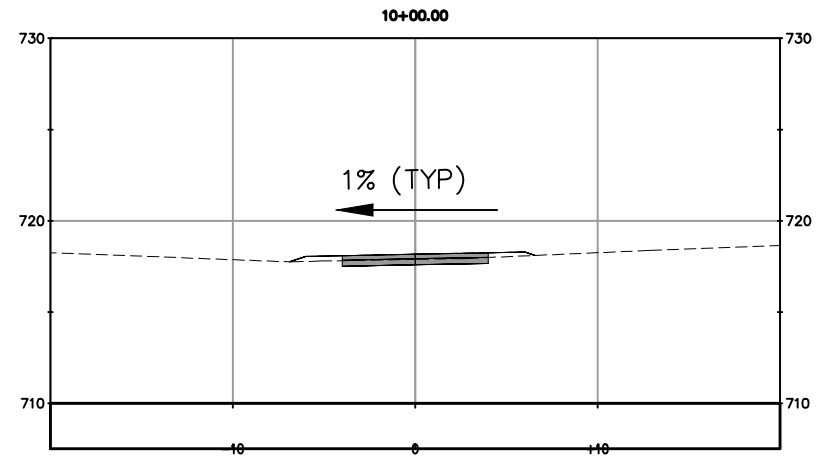
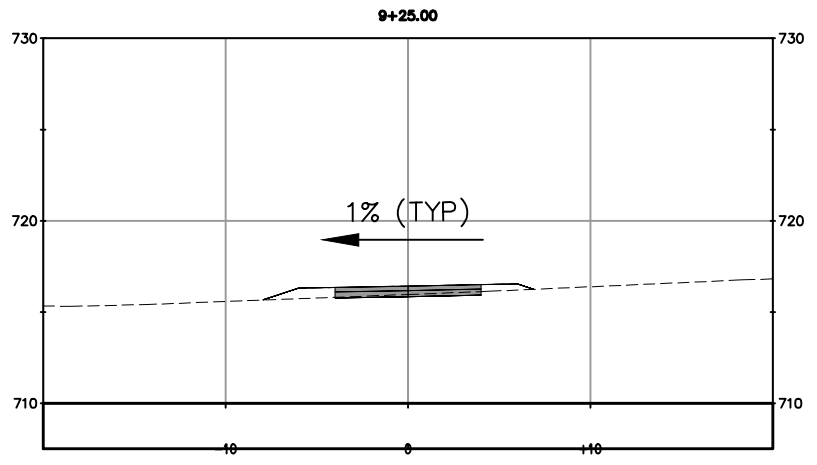
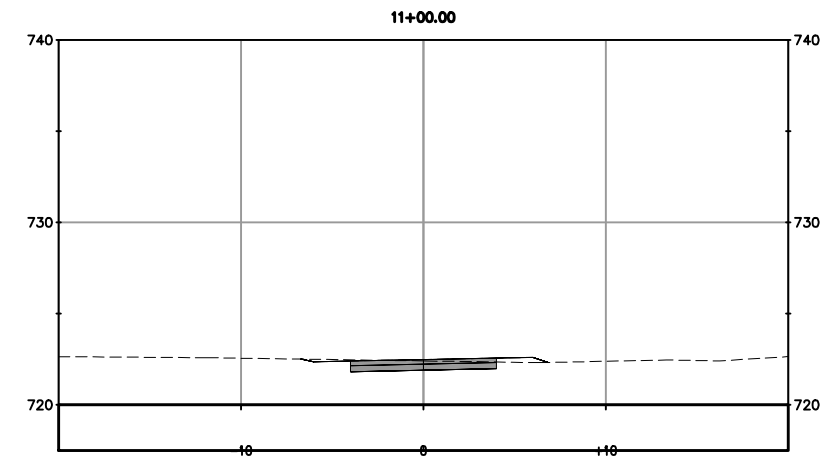
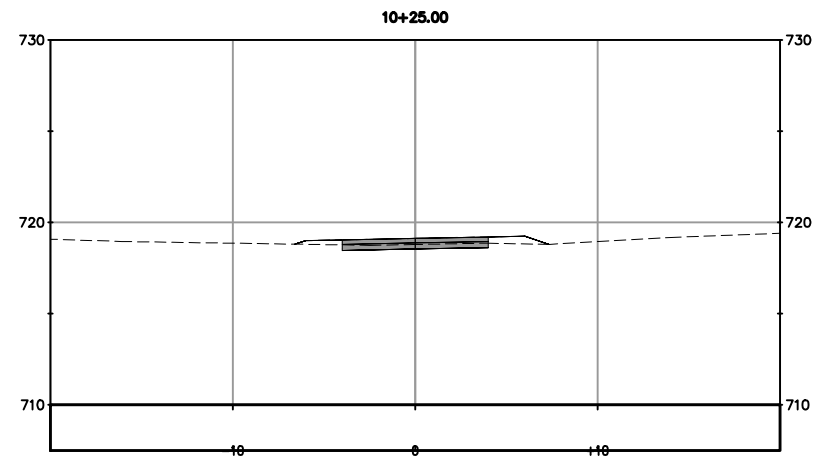
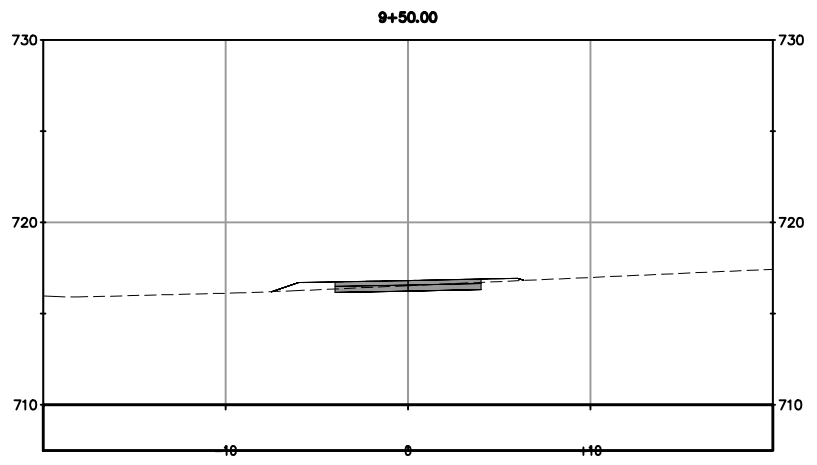
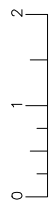

**BIKE TRAIL SECTIONS**  
SCALE: 1" = 10' H&V

**CROSS SECTIONS**  
SCALE : 1" = 10'

NUMBER	DATE	DESCRIPTION	BY

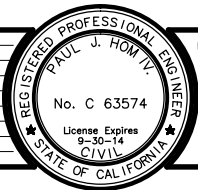

PREPARED UNDER THE SUPERVISION OF :  
 REGISTERED CIVIL ENGINEER  
 DATE:

DESIGNED: DRF  
 DRAWN: DRF  
 CHECKED: PH  
 DATE: 11/09/2012  
 ROAD NUMBER:



**EL DORADO COUNTY**  
**DEPARTMENT OF TRANSPORTATION**

**NEW YORK CREEK TRAIL (EAST)**  
**PHASE 1**

SHEET  
**X-3**  
 3 OF 6  
 W.O. No. **97005**

ORIGINAL SCALE IS IN INCHES  
 Drawing name: C:\Civil\_3D\Projects\97005-SMUD Trail TAM to SILVA\CADD Files\Production Drawings\SECTIONS.dwg Layout Tab: X-4 Nov 09,2012 - 11:55am DFriedstad

FOR REDUCED PLANS  
 REVISION

NUMBER	DATE	DESCRIPTION	BY

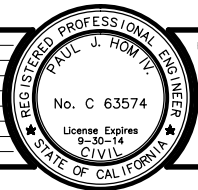

PREPARED UNDER THE SUPERVISION OF :  
 REGISTERED CIVIL ENGINEER  
 DATE:

DESIGNED: DRF  
 CHECKED: PH  
 ROAD NUMBER:

DRAWN: DRF  
 DATE: 11/09/2012



**EL DORADO COUNTY**  
**DEPARTMENT OF TRANSPORTATION**

**NEW YORK CREEK TRAIL (EAST)**  
**PHASE 1**

SHEET  
**X-4**  
 4 OF 6  
 W.O. No. **97005**

**BIKE TRAIL SECTIONS**

SCALE: 1" = 10' H&V

**CROSS SECTIONS**

SCALE: 1" = 10'

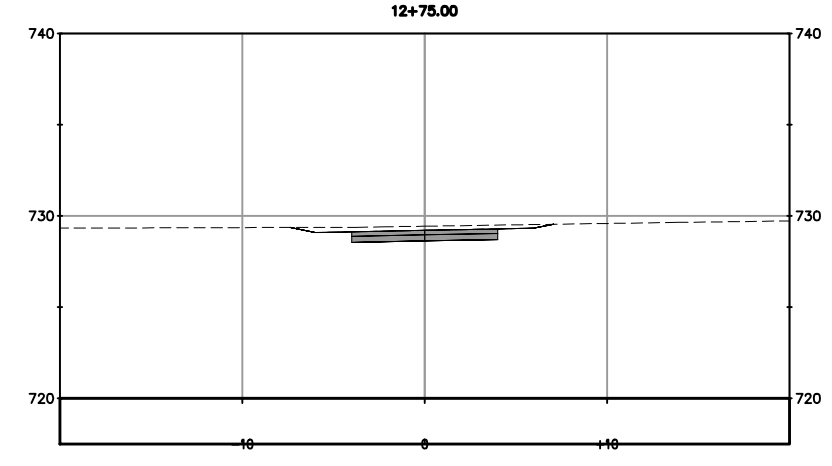
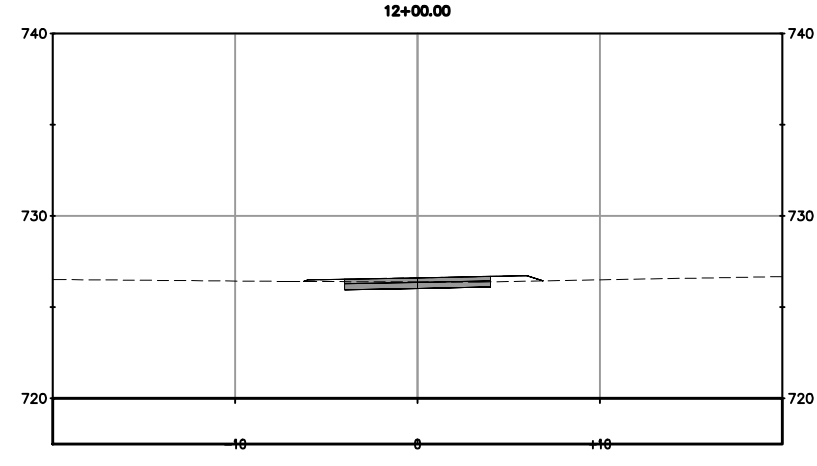
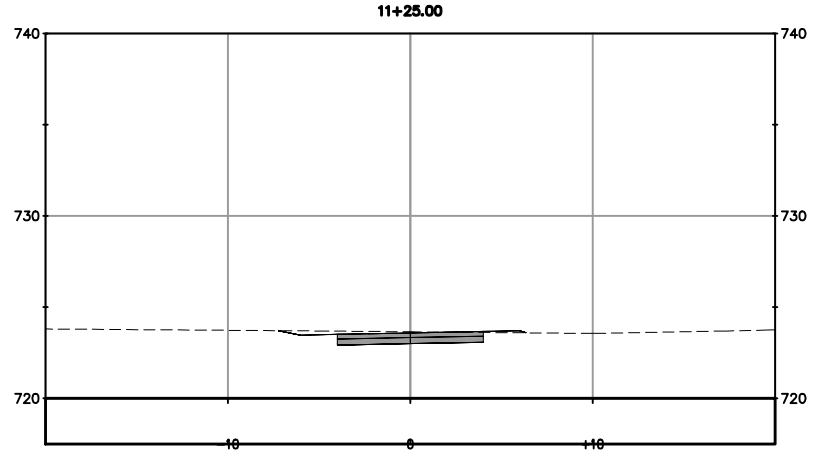
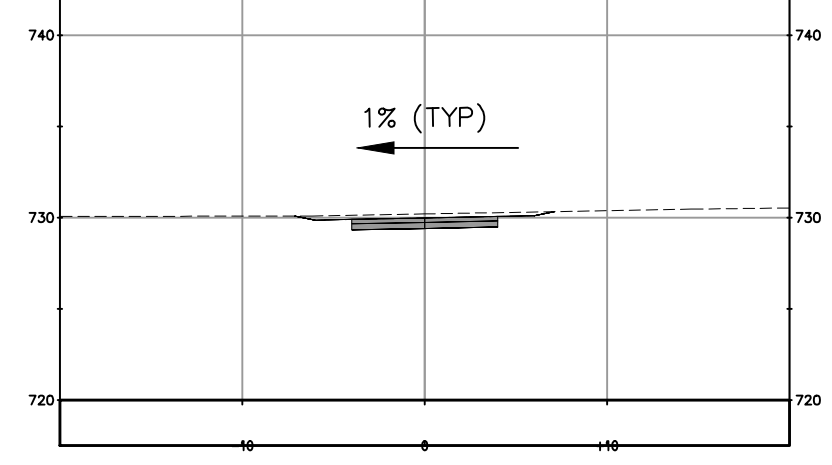
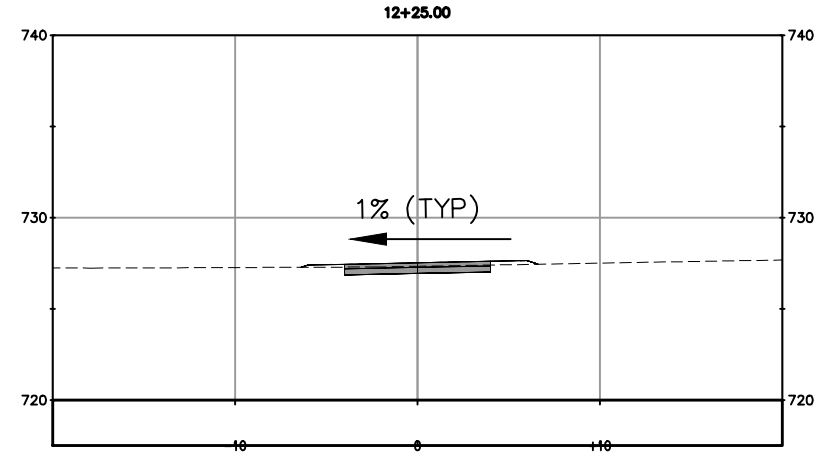
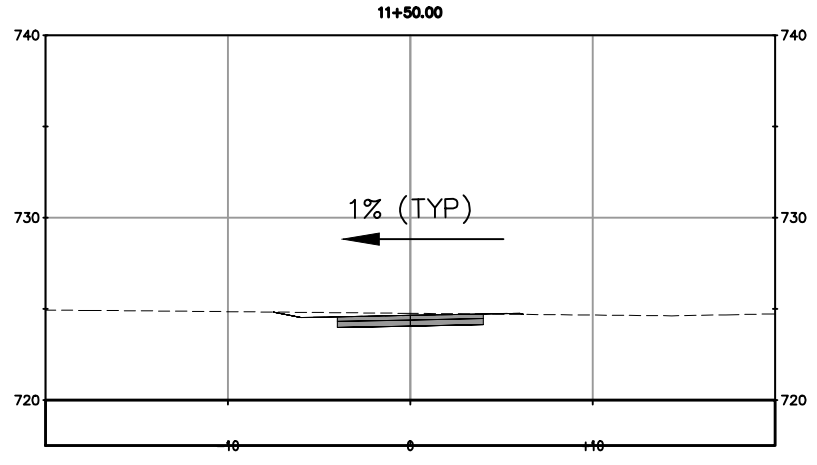
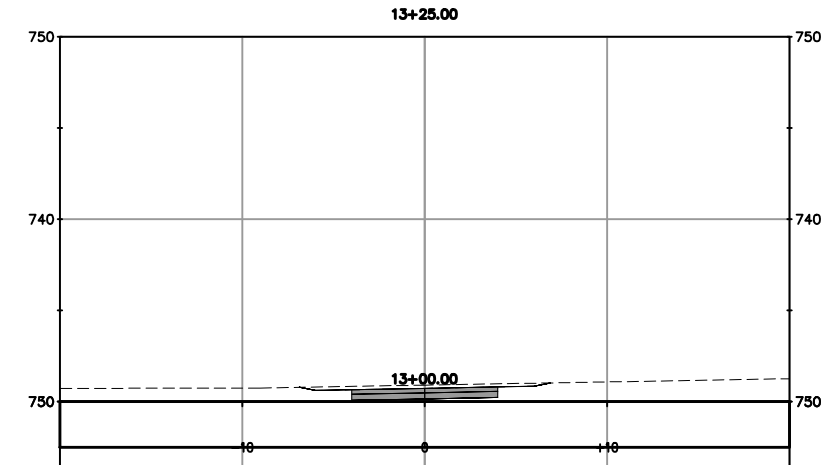
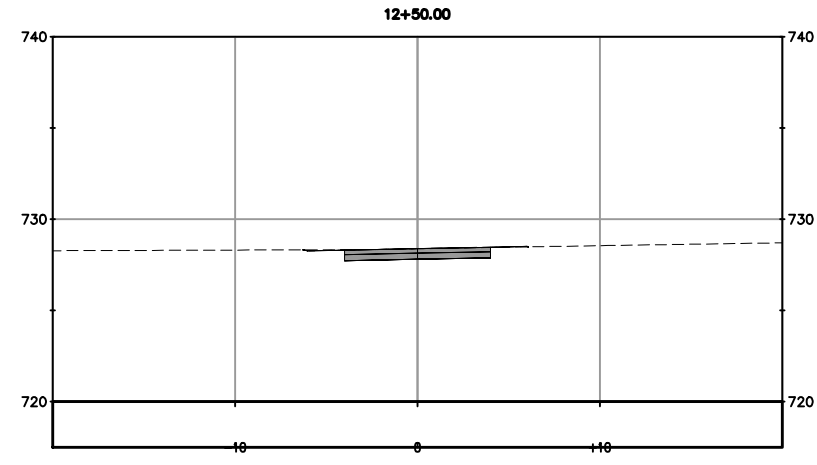
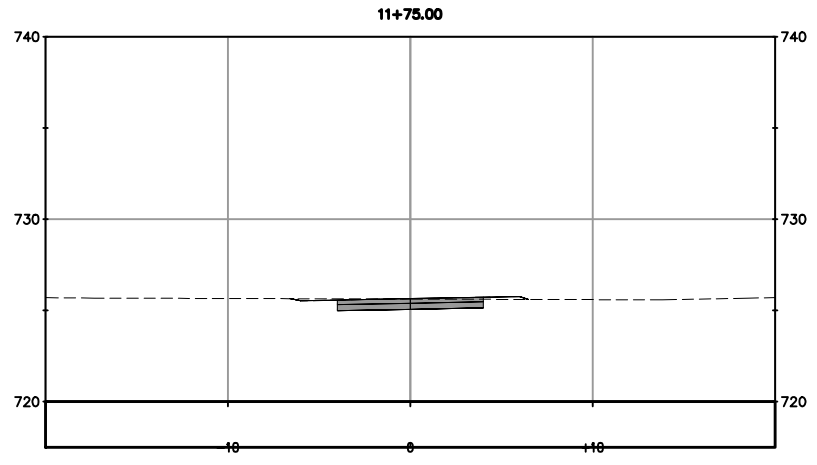

FOR REDUCED PLANS

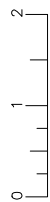

ORIGINAL SCALE IS IN INCHES

Drawing name: C:\Civil\_3D\Projects\97005-SMUD Trail TAM to SILVA\CADD Files\Production Drawings\SECTIONS.dwg

Layout Tab: X-5 Nov 09, 2012 - 11:56am DFriedstad

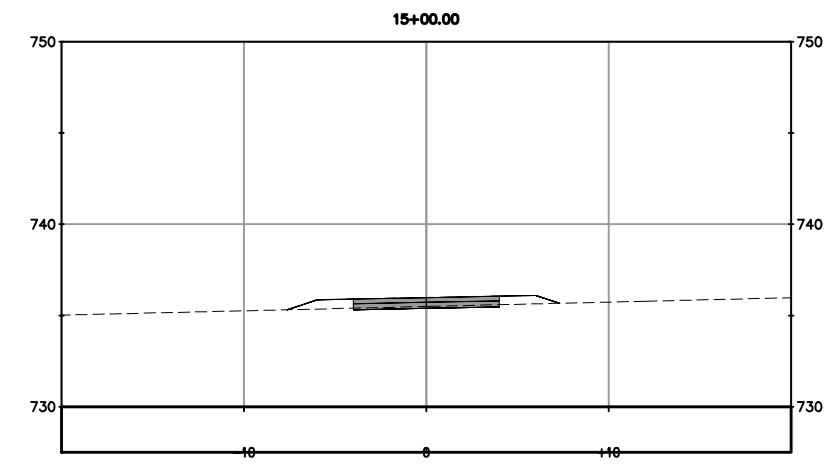
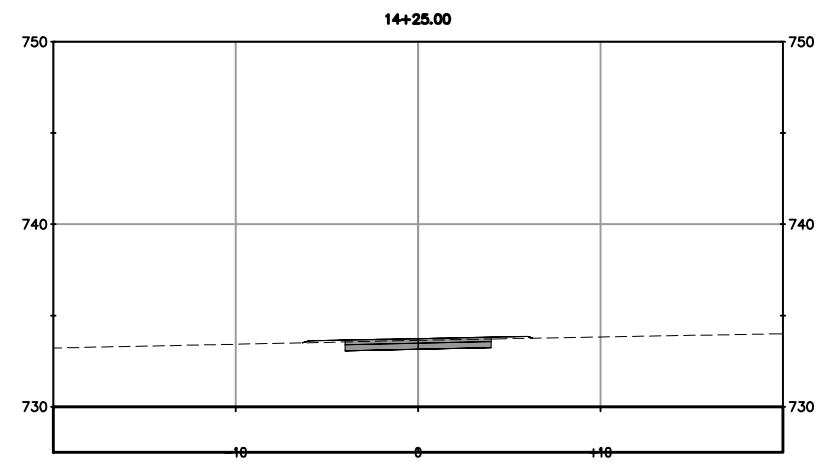
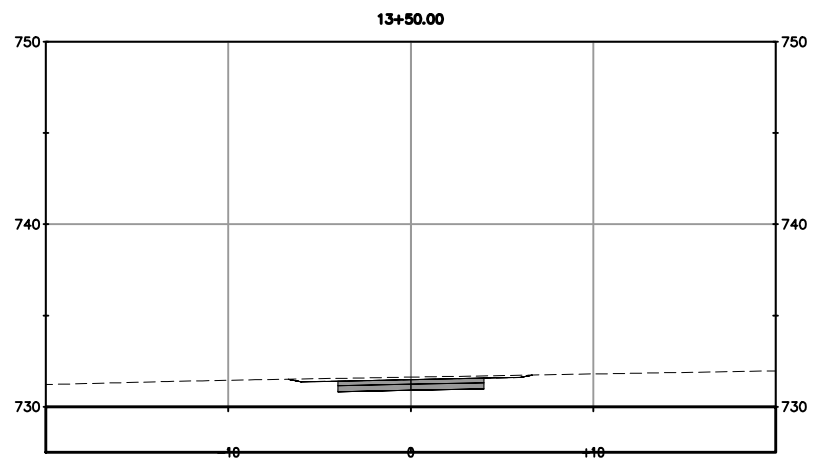
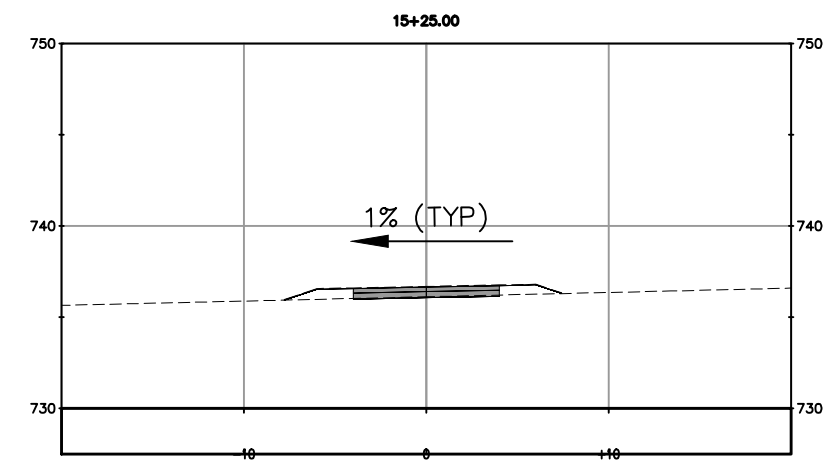
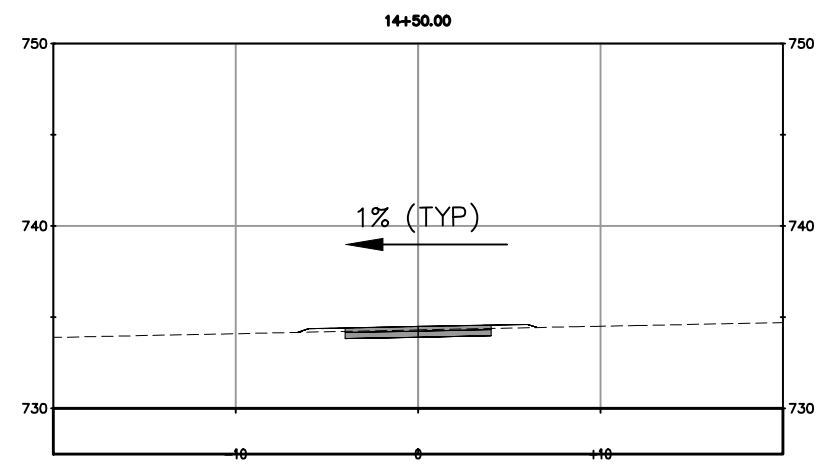
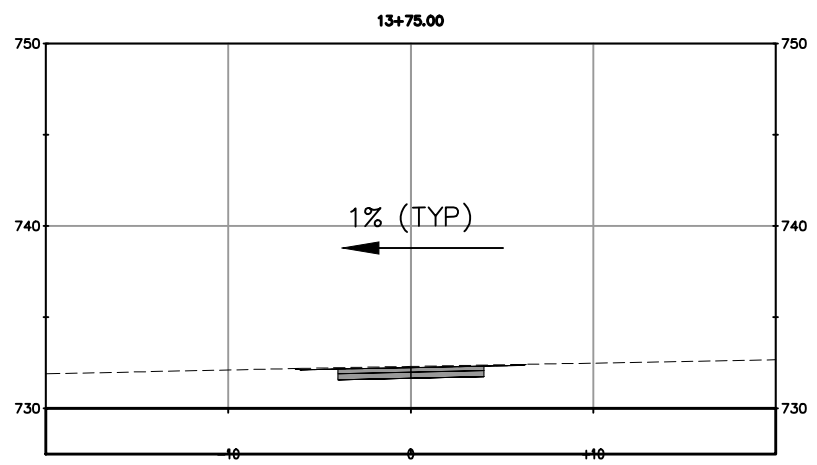
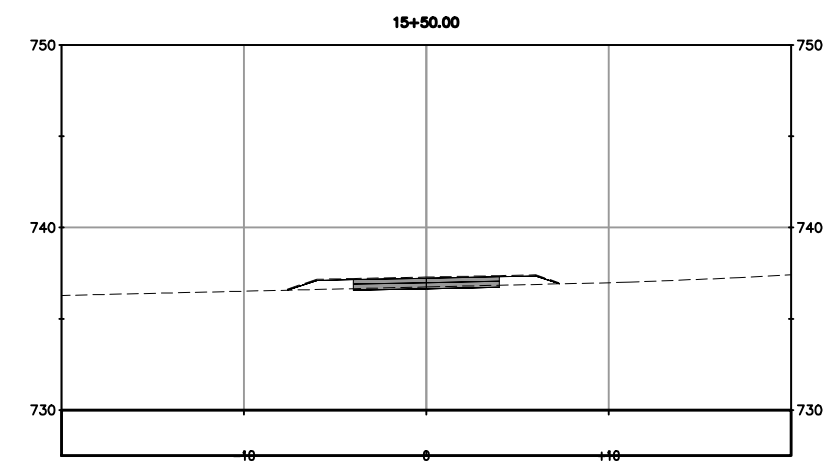
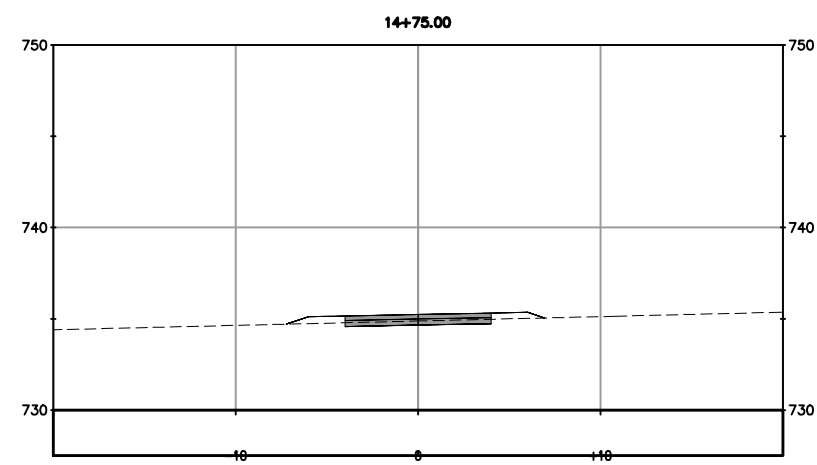
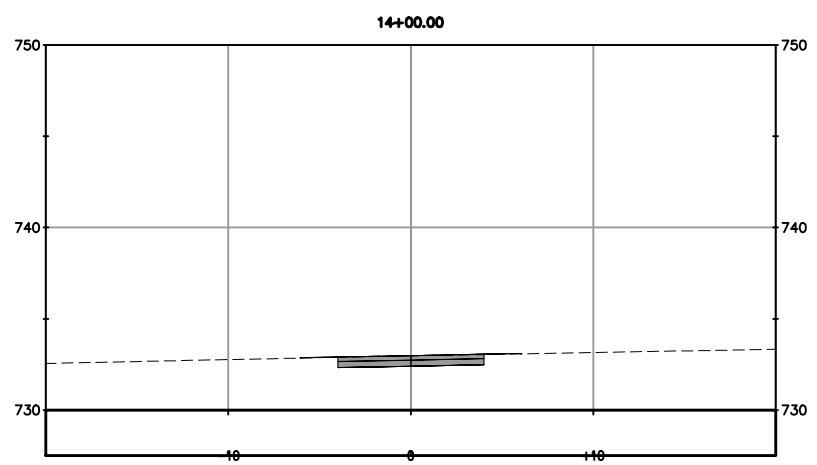

**BIKE TRAIL SECTIONS**

SCALE: 1" = 10' H&V

**CROSS SECTIONS**  
SCALE: 1" = 10'

REVISION	NUMBER	DATE	DESCRIPTION	BY

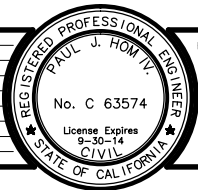

PREPARED UNDER THE SUPERVISION OF:  
 REGISTERED CIVIL ENGINEER  
 DATE:

DESIGNED: DRF  
 DRAWN: DRF  
 CHECKED: PH  
 DATE: 11/09/2012  
 ROAD NUMBER:



**EL DORADO COUNTY**  
**DEPARTMENT OF TRANSPORTATION**

**NEW YORK CREEK TRAIL (EAST)**  
**PHASE 1**

SHEET  
**X-5**  
 5 OF 6  
 W.O. No. **97005**

ORIGINAL SCALE IS IN INCHES  
 Drawing name: C:\Civil\_3D\Projects\97005-SMUD Trail TAM to SILVA\CADD Files\Production Drawings\SECTIONS.dwg Layout Tab: X-6 Nov 09,2012 - 11:56am DFriedstad

FOR REDUCED PLANS  
 REVISION

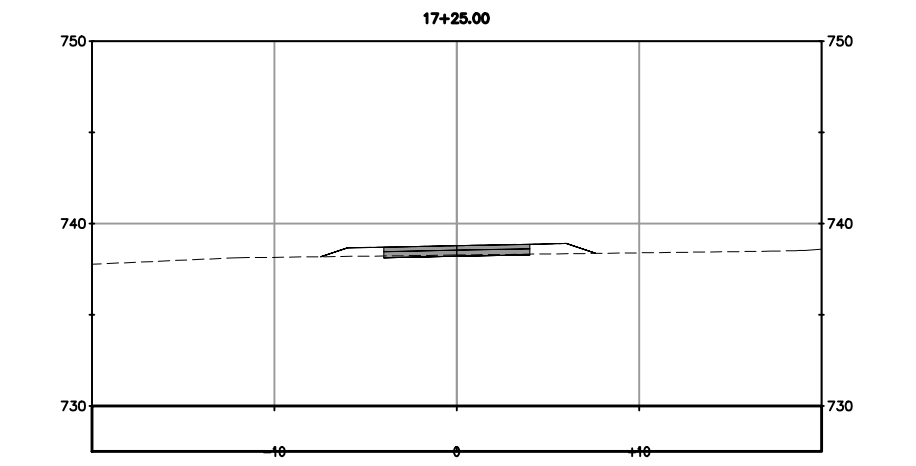
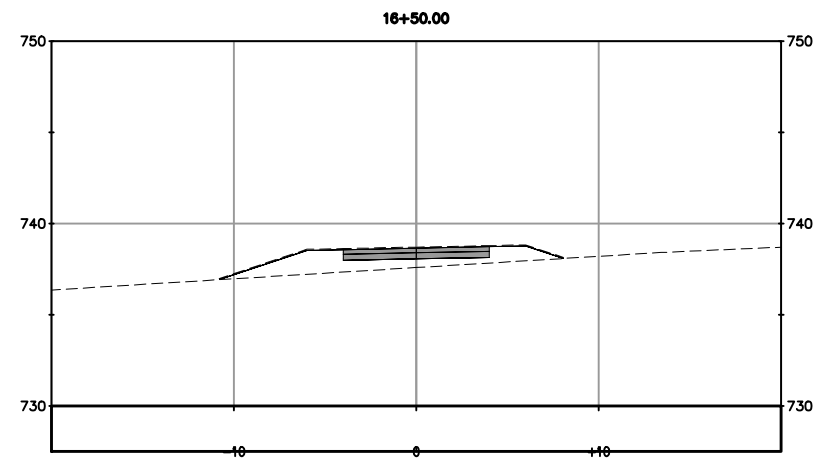
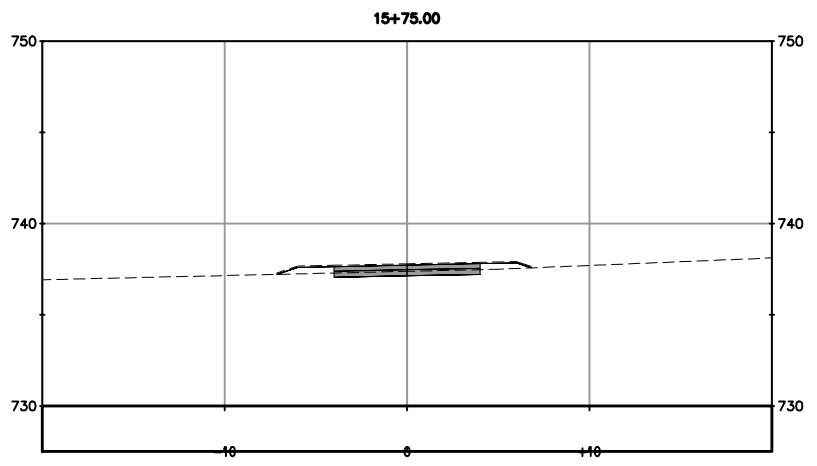
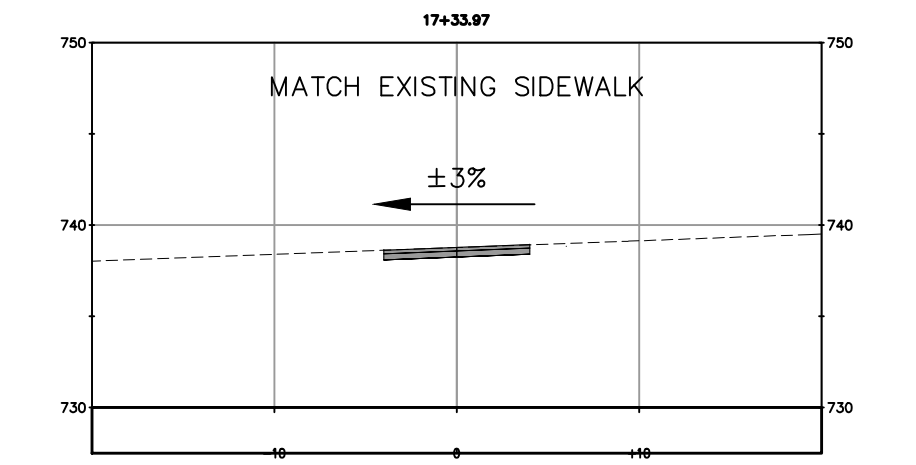
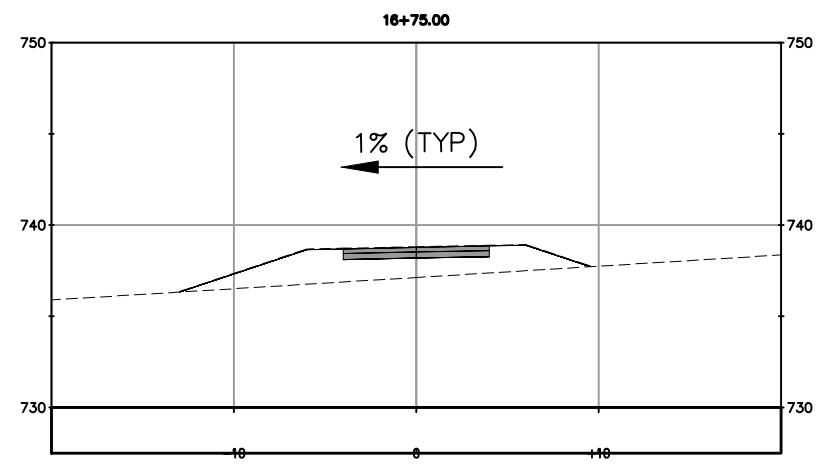
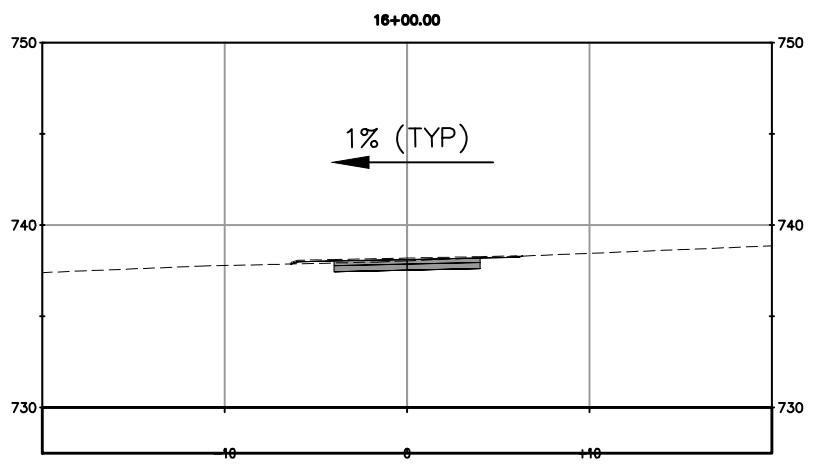
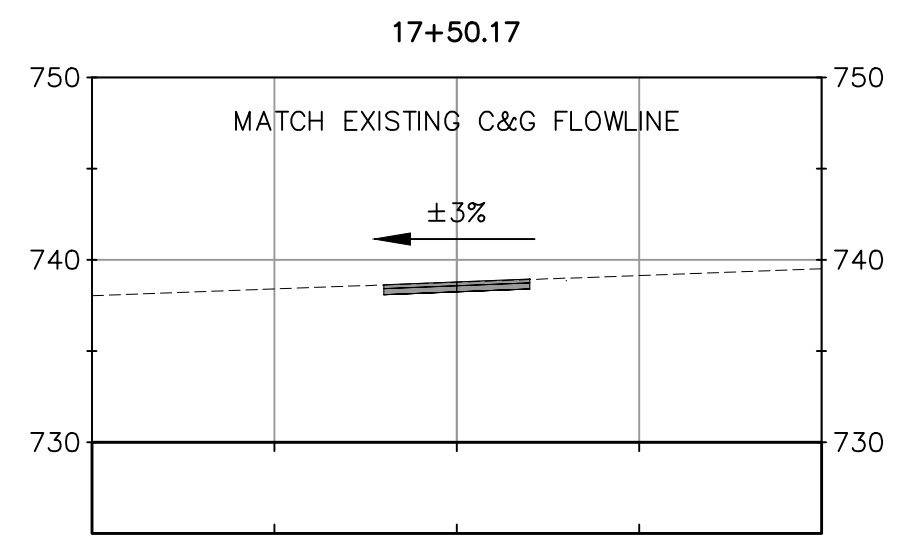
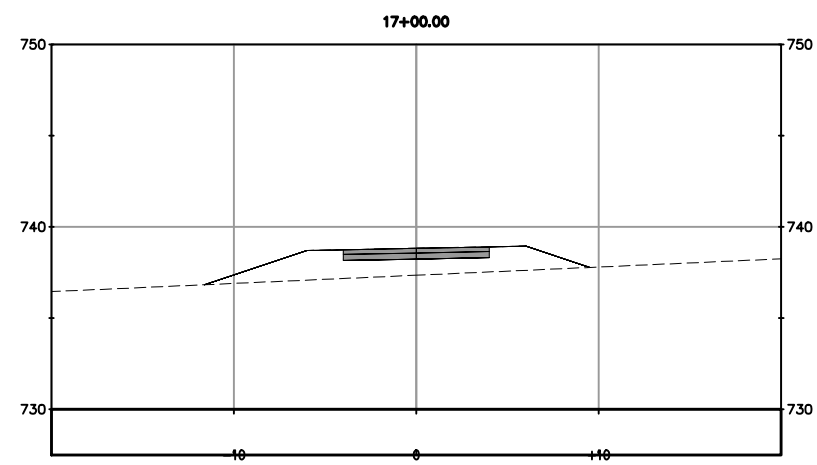
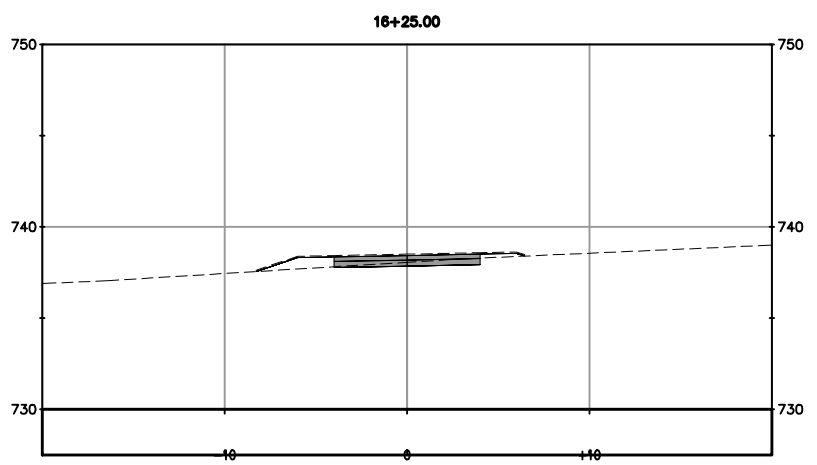

**BIKE TRAIL SECTIONS**

SCALE: 1" = 10' H&V

**CROSS SECTIONS**  
SCALE: 1" = 10'

NUMBER	DATE	DESCRIPTION	BY

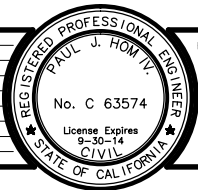

PREPARED UNDER THE SUPERVISION OF :  
 REGISTERED CIVIL ENGINEER  
 DATE:

DESIGNED: DRF  
 DRAWN: DRF  
 CHECKED: PH  
 DATE: 11/09/2012  
 ROAD NUMBER:



**EL DORADO COUNTY**  
**DEPARTMENT OF TRANSPORTATION**

**NEW YORK CREEK TRAIL (EAST)**  
**PHASE 1**

SHEET  
**X-6**  
 6 OF 6  
 W.O. No. **97005**