



CONSTRUCTION UNIT
 2441 Headington Road
 Placerville CA 95667
 Phone: (530) 642-4987
 Fax: (530) 295-2655

JAMES W. WARE, P.E.
 Director of Transportation

 Internet Web Site:
<http://edcgov.us/dot>

MAIN OFFICE
 2850 Fairlane Court
 Placerville CA 95667
 Phone: (530) 621-5900
 Fax: (530) 626-0387

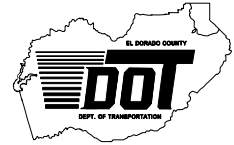

DATE: August 3, 2010

TO: All Prospective Bidders

SUBJECT: Addendum No. 1
Durock Road/ Business Drive Traffic Signal and Intersection
Widening Project (Contract No. PW 09-30446, CIP No. 73354)

Submit proposals for this work with the understanding and full consideration of this addendum. The revisions declared in this addendum are essential parts of the Contract.

ITEM NO.	LOCATION-PAGE OR DRAWING NO.	INQUIRY/RESPONSE
1.01	N-2 and SP-1	<p>Notice to Bidders and Section 1-1.01-</p> <p>Replace the first paragraph of N-2 and the last paragraph of Section 1-1.01 with the following:</p> <p><i>“The contract cross sections, the Geotechnical Engineering Study for the proposed Durock Road Widening Barnett Business Park, Unit II, Shingle Springs, El Dorado County, California by Carlton Engineering Inc.; the Project Update dated January 11, 2006 for Site Reconnaissance & Soil Classification Project 4543-01-33 Barnett BP Durock Widening ;and the Seismic Refraction Survey Motherlode Force Main Phase 2A, Shingle Springs, California by Paragon Geotechnical, Inc. are available to Contract Document holders as pdf files on the DOT website: http://www.edcgov.us/DOT/bids.html”</i></p>
1.02	Plan Sheet 17	<p>Plan Sheet E- 1 (sheet 17 of 20) has been revised. Bidders are instructed to replace the original plan sheet 17 of 20 with plan sheet 17 of 20 with 7/22/10 revision date attached to this addendum.</p>
1.03	SP-70 through SP-76	<p>Section 10-1.19 “Water Pollution Control”-</p> <p>Replace Section 10-1.19 with the Water Pollution Control special provisions included as Attachment A of this addendum.</p>

1.04	SP-110	After Section 10-1.50 “Modify Irrigation and Landscape Facilities” insert Sections 10-1.51 through 10-1.62 consisting of Construction Site Management and Temporary Best Management Practices (BMPs) special provisions included as Attachment B of this addendum.
1.05	N/A	Replace Section 88 “Engineering Fabrics” of the Standard Specifications with Attachment C of this addendum.
1.06	AB-1 through AB-3	Replace Appendix B Standard Plan List with the revised Standard Plan List included as Attachment D of this addendum.

The pages of this addendum other than the revised Plan Sheet shall be attached to the contract documents booklet.

Indicate receipt of this addendum by filling in the number of this addendum in the space provided on the signature page of the proposal.

Holders who have already mailed their proposal can contact Janel Gifford at (530) 642-4988 (email: Janel.Gifford@edcgov.us) to arrange return of their proposal.

Inform all suppliers and subcontractors as necessary.

The DOT is only sending this addendum by posting on the following website:
<http://www.edcgov.us/DOT/bids.html>.

If you are not a Contract Documents Holder, but request a set of documents to bid on this project, you must comply with the requirements of this addendum when submitting your bid.

Attachments:

- Sheet E-1 page 17 revised 7/22/10.
- Attachment A – Water Pollution Control – 17 pages
- Attachment B – Construction Site Management and Temporary BMPs special provisions - 56 pages
- Attachment C – Revised Section 88 of the Standard Specifications -7 pages
- Attachment D – Revised Appendix B Standard Plan List – 3 pages

End of Addendum No. 1



Recommended by:
Janel Gifford, P.E.
Office Engineer

8/3/10
Date

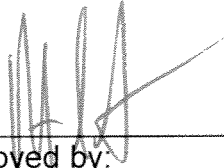

Approved by:
Robert S. Slater,
Acting Director of Transportation

8/3/10
Date

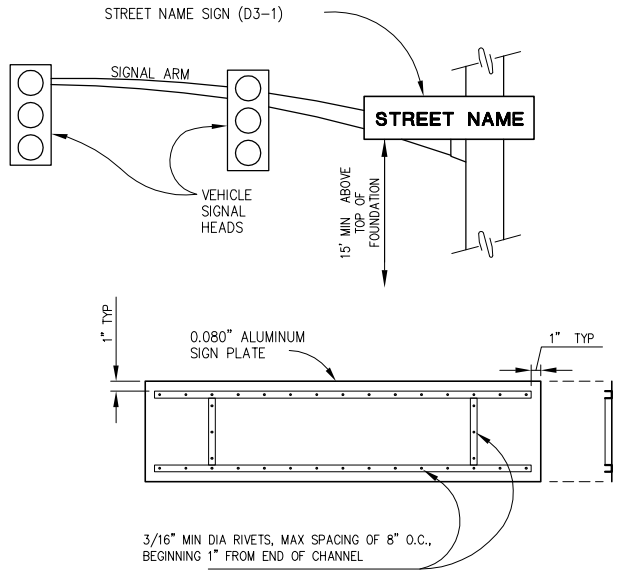

- NOTES:
1. ALL HANGER COMPONENTS TO BE GALVANIZED, EXCEPT STAINLESS STEEL BANDS.
 2. ATTACH SIGN TO POLE AND SIGNAL MAST ARM VIA SADDLE BRACKETS.
 3. SEE EQUIPMENT SCHEDULE FOR MESSAGE.
 4. SEE SPECIAL PROVISIONS FOR SIGN SPECIFICATIONS.
 5. FRAME MATERIAL: 1 1/4" X 1 1/4" X 3/16" ALUMINUM CHANNEL - ALLOY 6063-T5

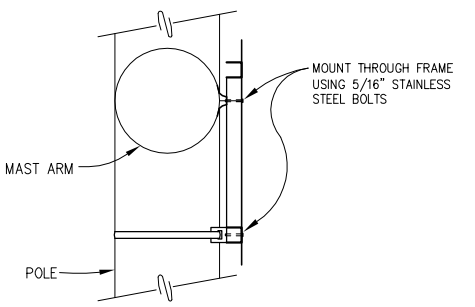

Street Name Sign Mounting Detail N.T.S. **3**

Sheet Notes

1. INSTALL D3 SIGN AS SHOWN ON POLE SCHEDULE. PER DETAIL 3 ON THIS SHEET.
 2. INSTALL COUNTY FURNISHED CONTROLLER CABINET ASSEMBLY WITH MODEL 988 CONTROLLER. FRONT DOOR OF CONTROLLER SHALL FACE WEST.
 3. INSTALL COUNTY FURNISHED TESCO MODEL 27-22 SERVICE EQUIPMENT ENCLOSURE WITH BATTERY PACK SYSTEM (BBS) CABINET. DOOR OF ELECTRICAL SERVICE ENCLOSURE SHALL FACE WEST AND THE DOOR FOR THE BBS ENCLOSURE SHALL FACE EAST. SEE CONTROLLER AND SERVICE PAD DETAIL, SHEET E-2.
 4. PG&E TO INSTALL CABLE FROM TRANSFORMER TO #6 PULL BOX.
- NOTE:
1. ALL WORK SHALL BE DONE IN ACCORDANCE WITH CALTRANS STANDARD PLANS AND SPECIFICATIONS DATED MAY 2006, AND THE CALIFORNIA MUTCD.

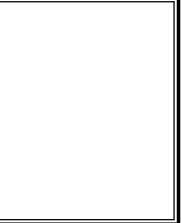

Revisions

NO.	DESCRIPTION	DATE	BY
1	REVISION	07/22/10	SM

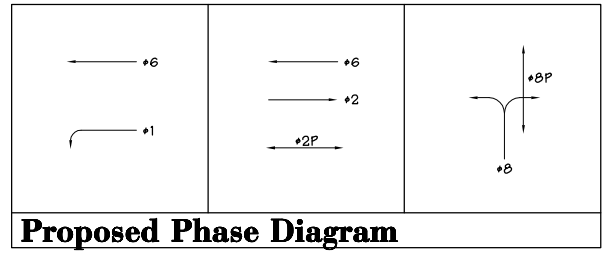
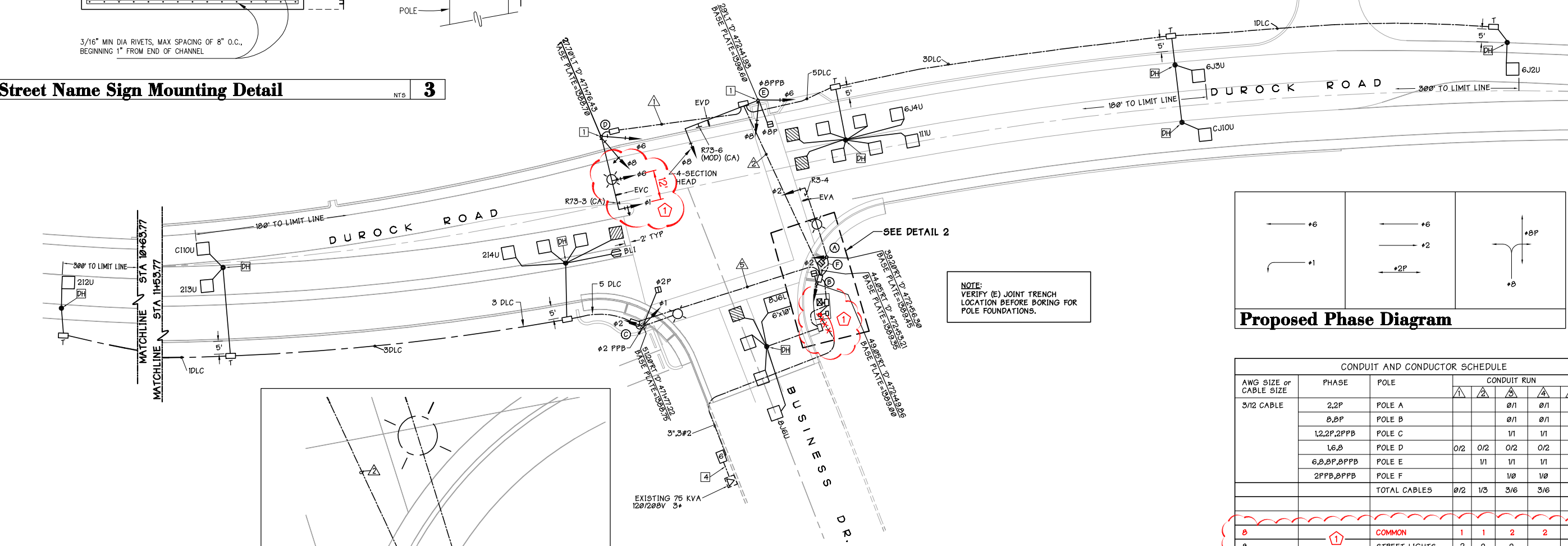

CONDUIT AND CONDUCTOR SCHEDULE

AWG SIZE or CABLE SIZE	PHASE	POLE	CONDUIT RUN					
			1	2	3	4	5	
3/12 CABLE	2,2P	POLE A			0/1	0/1		
	8,8P	POLE B			0/1	0/1		
	1,2,2P,2PPB	POLE C			1/1	1/1	1/1	
	1,6,8	POLE D	0/2	0/2	0/2	0/2		
	6,8,8P,8PPB	POLE E			1/1	1/1	1/1	
	2PPB,8PPB	POLE F			1/0	1/0		
	TOTAL CABLES		0/2	1/3	3/6	3/6	1/1	

8	COMMON	1	1	2	2	1	
8	STREET LIGHTS	2	2	2		2	
	TOTAL #8	3	3	4	2	3	
6	CONTROLLER					2	
DLC	BLI			1	1	1	
	#1 DETECTOR		1	1	1		
	#2 DETECTOR			3	3	3	
	#6 DETECTOR		3	3	3		
	#8 DETECTOR					2	
	COUNT		1	2	2	1	
EMERGENCY	VEHICLE		1	2	3	3	
	TOTAL DLC + EV	1	7	12	15	5	
	TOTAL	5	6	14	24	28	3
	CONDUIT SIZE	3"	3 1/2"	2-3 1/2"	2-3 1/2"	3"	

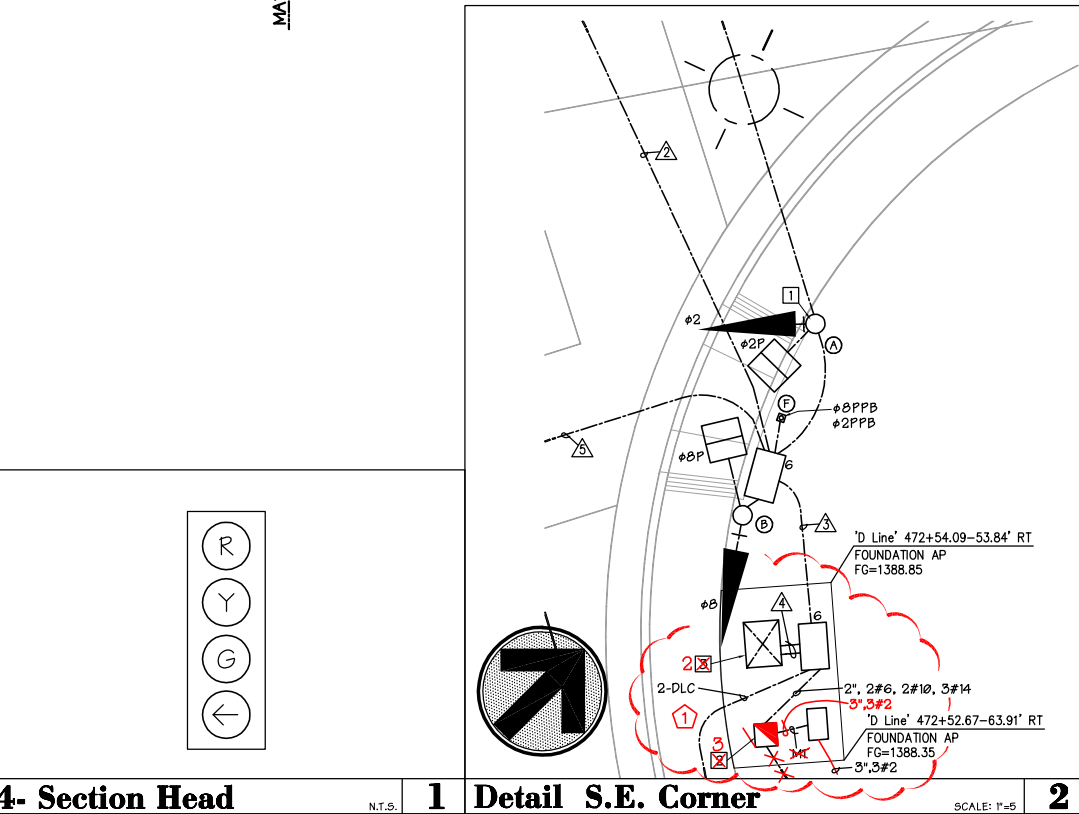

Plan View 1"=20'

POLE AND EQUIPMENT SCHEDULE

POLE	STANDARD		VEHICLE SIGNAL		PEDESTRIAN SIGNAL		PPB	HPS LUMINAIRE	NOTES		
	TYPE	Sig MA	Lum MA	Ø	TYPE	MOUNTING				Ø	MOUNTING
(A)	19-2-10Ø	25' EVA	12'	2 12	MAS	2	SP-1-T	200W	D3-BUSINESS DR. INSTALL R3-4		
(B)	1-B			8 12	TV-1-T	1	SP-1-T				
(C)	15TØ		12'	1 AA	SV-2-T	2	SP-1-T	2	LEFT	200W	INSTALL R9-3A R9-3B (LT)
(D)	19-3-10Ø	30' EVC	12'	1 AA	MAS			200W		D3-BUSINESS DR. INSTALL R73-3(CA) INSTALL R9-3A R9-3B (RT)	
(E)	19-2-10Ø	30' EVD		8 12A	MAS-4B	8	SP-1-T	Ø	RIGHT		D3-DUROCK ROAD INSTALL R61-19(CA)
(F)	PPB POST			8 12	SV-2-TB	1			Ø	LEFT	
				6 12					2	RIGHT	

12 = ALL 12" LED SIGNAL SECTIONS, AA = ALL ARROW LED SIGNAL SECTIONS, EVA, EVC, & EVD EMERGENCY VEHICLE PREEMPTION SENSOR
12A = 4 SECTION HEAD (SEE DETAIL 1, THIS SHEET)

3 CONDUCTOR CABLE IS PPB, 12 CONDUCTOR IS TRAFFIC SIGNAL
NOTE: THIS SHEET ACCURATE FOR ELECTRICAL WORK ONLY.

DUROCK ROAD & BUSINESS DRIVE
TRAFFIC SIGNAL & INTERSECTION WIDENING
TRAFFIC SIGNAL AND LIGHTING PLAN

COUNTY OF EL DORADO
DEPARTMENT OF TRANSPORTATION
Ownership Information:
SUBMITTAL DATE: 05-14-10

DESIGNED: DATE
DRAWN: ACR/RES
JOB No: ASR
SHEET: A3 SHOWN
VERT. SCALE: N/A
E-1
17

10-1.19 WATER POLLUTION CONTROL

Water pollution control work shall conform to the provisions in Section 7-1.01G, "Water Pollution," of the Standard Specifications and these special provisions.

This project lies within the boundaries of the Central Valley (Sacramento) Regional Water Quality Control Board (RWQCB).

A 401 Water Quality Certification and Waste Discharge Requirements for Discharge of Dredged and/or Fill Material, WDID #5A34CR00377, has been issued for impacts to waters of the United States. The Contractor shall be fully informed of the requirements of this permit as well as rules, regulations, and conditions that may govern the Contractor's operations in these areas and shall conduct the work accordingly. If there are any conflicts between this certification and these special provisions the more restrictive shall apply.

The Engineer will provide the turbidity and settleable material testing associated with this permit.

A copy of WDID #5A34CR00377 is included in the appendices of these special provisions and is therefore specifically incorporated into the contract documents.

This project shall conform to the permits and modifications thereto. The Contractor shall maintain copies of the permits at the project site and shall make them available during construction.

The Contractor shall notify the Engineer within two weeks of beginning work within the stream zone of this project. The allowable turbidity and settleable material limits shall not be exceeded.

This project is subject to the current Statewide General Permit issued by the SWRCB entitled "Order No. 2009-0009 DWQ, National Pollutant Discharge Elimination System (NPDES) General Permit No. CAS000002, Waste Discharge Requirements (WDRs) for Discharges of Storm Water Associated with Construction and Land Disturbance Activities," which regulates discharges of storm water and non-storm water from construction activities disturbing one (1) or more acres of soil in a common plan of development. Copies of the Statewide General Permit and modifications thereto are available for review from the SWRCB, Division of Water Quality, 1001 "I" Street, P.O. Box 100, Sacramento, California 95812-0100, Telephone: (916) 341-5463 and may also be obtained from the SWRCB Internet website at: http://www.waterboards.ca.gov/water_issues/programs/stormwater/

If the Contractor fails to properly mitigate storm water and non-storm water discharges such that the Central Valley Regional Water Quality Control Board (CVRWQCB) assigns a Risk Level greater than 1 under the new Statewide General Permit, Contractor shall be responsible for all additional costs incurred above and beyond that which would have been incurred under Risk Level 1.

The Contractor shall know and comply with provisions of Federal, State, and local regulations and requirements that govern the Contractor's operations and storm water and non-storm water discharges from the project site and areas of disturbance outside the project limits during construction. Attention is directed to Sections 7-1.01, "Laws to be Observed," 7-1.11, "Preservation of Property," 7-1.12, "Indemnification and Insurance," 8-1.10 "Utility and Non-Highway Facilities," and 9-1.055 "Penalty Withholds" of the Standard Specifications.

The Contractor shall notify the Engineer immediately upon request from the regulatory agencies to enter, inspect, sample, monitor, or otherwise access the project site or the Contractor's records pertaining to water pollution control work. The Contractor and the Department shall provide copies of correspondence, notices of violation, enforcement actions, or proposed fines by regulatory agencies to the requesting regulatory agency.

GENERAL

Summary

Discharges of storm water from the project must comply with NPDES General Permit for "Storm Water Discharges Associated with Construction and Land Disturbance Activities" (Order No. 2009-0009-DWQ, NPDES No. CAS000002) hereinafter called the "Permit." Manage work activities to reduce the discharge of pollutants to surface waters, groundwater, or municipal separate storm sewer systems including work items shown in the Bid Item List for:

1. Prepare Storm Water Pollution Prevention Plan. SWPPP preparation includes obtaining SWPPP acceptance, amending the SWPPP, preparing a CSMP and a SAP, and monitoring and inspecting WPC practices at the job site.
2. Storm Water Annual Report. Storm Water Annual Report preparation includes certifications, monitoring and inspection results, and obtaining Storm Water Annual Report acceptance.
3. Storm Water Sampling and Analysis Day. Storm Water Sampling and Analysis Day includes reporting of storm water quality per qualifying rain event. If specified for the risk level, the work includes preparation, collection, analysis, and reporting of storm water samples for turbidity, pH, and other constituents.
4. Rain Event Action Plan. If specified for the project risk level, REAP preparation includes preparing and submitting REAP forms and monitoring weather forecasts.

Do not start work until:

1. SWPPP is accepted
2. WDID is issued

This project is Risk Level 1.

Definitions and Abbreviations

active and inactive areas: (1) Active areas have soil disturbing work activities occurring at least once within 14 days, and (2) Inactive areas are areas that have not been disturbed for at least 15 days.

BMPs: Best Management Practices are water pollution control practices.

construction phase: Construction phases are (1) Highway Construction including work activities for building roads and structures, (2) Plant Establishment including maintenance on vegetation installed for final stabilization, and (3) Suspension where work activities are suspended and areas are inactive.

CSMP: Construction Site Monitoring Program.

NAL: Numeric Action Level.

NEL: Numeric Effluent Limit.

NPDES: National Pollutant Discharge Elimination System.

NOI: Notice of Intent.

normal working hours: The hours you normally work on this project.

Preparation Manual: The Caltrans "Storm Water Pollution Prevention Plan and Water Pollution Control Program Preparation Manual."

QSD: Qualified SWPPP Developer.

QSP: Qualified SWPPP Practitioner.

qualified rain event: A qualified rain event is a storm that produces at least 0.5 inch of precipitation with a 48 hour or greater period between storms.

REAP: Rain Event Action Plan.

RWQCB: Regional Water Quality Control Board.

SAP: Sampling and Analysis Plan.

SSC: Suspended Sediment Concentration.

SWRCB: State Water Resources Control Board.

SWPPP: Storm Water Pollution Prevention Plan.

WDID: Waste Discharge Identification Number.

WPC: Water Pollution Control.

WPC Manager: Water Pollution Control Manager. The WPC Manager implements water pollution control work described in the SWPPP and oversees revisions and amendments to the SWPPP.

Submittals

Within 5 days after contract approval, start the following process for SWPPP acceptance:

1. Submit 3 copies of the SWPPP and allow 5 days for the Engineer's review. If revisions are required, the Engineer provides comments and specifies the date that the review stopped.
2. Change and resubmit the SWPPP within 2 days of receipt of the Engineer's comments. The Engineer's review resumes when the complete SWPPP is resubmitted.
3. When the Engineer accepts the SWPPP, submit an electronic and 4 printed copies of the accepted SWPPP.

Submit:

1. Storm water training records including training dates and subjects for employees and subcontractors. Include dates and subjects for ongoing training, including tailgate meetings.
2. Employee training records:
 - 2.1. Within 5 days of SWPPP acceptance for existing employees
 - 2.2. Within 5 days of training for new employees
 - 2.3. At least 5 days before subcontractors start work for subcontractor's employees

Prepare a Storm Water Annual Report for the reporting period from July 1st to June 30th. For the prior reporting period, submit the report no later than July 15th if construction occurs from July 1st through June 30th or within 15 days after contract acceptance if construction ends before June 30th.

Submit the Storm Water Annual Report as follows:

1. Submit 2 copies of the Storm Water Annual Report and allow 10 days for the Engineer's review. If revisions are required, the Engineer provides comments and specifies the date that the review stopped.
2. Change and resubmit the Storm Water Annual Report within 5 days of receipt of the Engineer's comments. The Engineer's review resumes when the complete Storm Water Annual Report is resubmitted.
3. When the Engineer accepts the Storm Water Annual Report, insert the WPC Manager's signed certification and the Engineer's signed certification.

Submit one electronic copy and 2 printed copies of the accepted Storm Water Annual Report.

Submit as required:

1. NAL Exceedance Reports
2. NEL Exceedance Reports
3. Visual Monitoring Reports
4. Inspection Reports
5. BMP Status Report

At least 5 days before operating any construction support facility, submit:

1. A plan showing the location and quantity of WPC practices associated with the construction support facility
2. A copy of the NOI approved by the RWQCB and the SWPPP approved by the RWQCB if you will be operating a batch plant or a crushing plant under the General Industrial Permit

Quality Control and Assurance

Training

Provide storm water training for:

1. Project managers
2. Supervisory personnel
3. Employees involved with WPC work

Train all employees, including subcontractor's employees, in the following subjects:

1. WPC rules and regulations
2. Implementation and maintenance for:
 - 2.1. Temporary Soil Stabilization
 - 2.2. Temporary Sediment Control
 - 2.3. Tracking Control
 - 2.4. Wind Erosion Control
 - 2.5. Material pollution prevention and control
 - 2.6. Waste management
 - 2.7. Non-storm water management
 - 2.8. Identifying and handling hazardous substances
 - 2.9. Potential dangers to humans and the environment from spills and leaks or exposure to toxic or hazardous substances

Employees must receive initial WPC training before working on the job site.

Conduct weekly training meetings covering:

1. WPC BMP deficiencies and corrective actions
2. BMPs that are required for work activities during the week
3. Spill prevention and control
4. Material delivery, storage, use, and disposal
5. Waste management
6. Non-storm water management procedures

Training for personnel to collect water quality samples must include:

1. SAP review
2. Health and safety review
3. Sampling simulations

If you operate construction support facilities, protect storm water systems or receiving waters from the discharge of potential pollutants by using WPC practices.

Construction support facilities include:

1. Staging areas
2. Storage yards for equipment and materials
3. Mobile operations
4. Batch plants for PCC and HMA
5. Crushing plants for rock and aggregate
6. Other facilities installed for your convenience such as haul roads

If you operate a batch plant to manufacture PCC, HMA, or other material; or a crushing plant to produce rock or aggregate; obtain coverage under the General Industrial General Permit. You must be covered under the General Industrial Permit for batch plants and crushing plants located:

1. Outside of the job site
2. Within the job site that serve one or more contracts

Discharges from manufacturing facilities such as batch plants must comply with the general waste discharge requirements for Order No. 97-03-DWQ, NPDES General Permit No. CAS000001, issued by the SWRCB for "Discharge of Stormwater Associated with Industrial Activities Excluding Construction Activities." For the General Industrial Permit, go to:

<http://www.waterboards.ca.gov/>

You may obtain copies of the Preparation Manual from the Publication Distribution Unit. The mailing address for the Publication Distribution Unit is:

State of California
Department of Transportation
Publication Distribution Unit
1900 Royal Oaks Drive
Sacramento, California 95815
Telephone: (916) 445-3520

The Preparation Manual and other WPC references are available at Caltrans "Construction Storm Water and Water Pollution Control" Web site. For the Web site, go to:

<http://www.dot.ca.gov/hq/construc/stormwater/stormwater1.htm>

Water Pollution Control Manager

Assign one WPC Manager to implement the SWPPP. The WPC Manager must comply with the Permit qualifications for a QSP and a QSD. You may assign a different QSD to prepare the SWPPP.

The QSD must have the following qualifications:

1. Caltrans approved storm water management training described in the Caltrans "Construction Storm Water and Water Pollution Control" web site
2. Registration or certification described in the Permit

The QSP must meet the qualifications of the QSD or have the following certifications:

1. Caltrans approved storm water management training described in the Caltrans "Construction Storm Water and Water Pollution Control" web site
2. Certification described in the Permit

At the job site, the WPC Manager must:

1. Be responsible for WPC work
2. Be the primary contact for WPC work
3. Oversee the maintenance of WPC practices
4. Oversee and enforce hazardous waste management practices
5. Have the authority to mobilize crews to make immediate repairs to WPC practices
6. Ensure that all employees have current water pollution control training
7. Implement the accepted SWPPP and amend the SWPPP when required

WPC Manager must oversee:

1. Inspections of WPC practices identified in the SWPPP
2. Inspections and reports for visual monitoring
3. Preparation and implementation of REAPs
4. Sampling and analysis
5. Preparation and submittal of:
 - 5.1. NAL exceedance reports
 - 5.2. NEL exceedance reports
 - 5.3. SWPPP annual certification
 - 5.4. Annual reports
 - 5.5. BMP status reports

STORM WATER POLLUTION PREVENTION PLAN (SWPPP)

General

SWPPP work includes preparing a SWPPP including a CSMP, obtaining SWPPP acceptance, amending the SWPPP, inspecting and reporting on WPC practices at the job site. The SWPPP must comply with the Preparation Manual and the Permit. The SWPPP must be submitted in place of the water pollution control program under Section 7-1.01G, "Water Pollution," of the Standard Specifications.

You may request, or the Engineer may order, changes to the WPC work. Changes may include the addition of new WPC practices. Additional WPC work will be paid for as extra work under Section 4-1.03D, "Extra Work," of the Standard Specifications.

The SWPPP must include sections as specified for the project risk level as follows:

1. For risk level 1:
 - 1.1. Schedule
 - 1.2. CSMP
2. For risk level 2:
 - 2.1. Schedule
 - 2.2. CSMP
 - 2.3. Adherence to Effluent Standards for NALs
 - 2.4. REAP

3. For risk level 3:
 - 3.1. Schedule
 - 3.2. CSMP
 - 3.3. Adherence to Effluent Standards for NALs and NELs
 - 3.4. REAP

The SWPPP must include WPC practices for:

1. Storm water and non-stormwater from areas outside of the job site related to project work activities such as:
 - 1.1. Staging areas
 - 1.2. Storage yards
 - 1.3. Access roads
2. Activities or mobile operations related to contractor obtained NPDES permits
3. Construction support facilities

The SWPPP must include a copy of permits obtained by the Department such as Fish & Game permits, US Army Corps of Engineers permits, RWQCB 401 Certifications, and RWQCB Waste Discharge Requirements for Aerially Deposited Lead Reuse.

Amend the SWPPP annually and resubmit it by July 15th.

Amend the SWPPP if:

1. Changes in work activities could affect the discharge of pollutants
2. WPC practices are added by change order work
3. WPC practices are added at your discretion
4. Changes in the amount of disturbed soil are substantial
5. Objectives for reducing or eliminating pollutants in storm water discharges have not been achieved
6. There is a Permit violation

Whenever you amend the SWPPP, follow the same process specified for SWPPP acceptance. Retain a printed copy of the accepted SWPPP at the job site.

SWPPP Schedule

The SWPPP schedule must:

1. Describe when work activities will be performed that could cause the discharge of pollutants into storm water
2. Describe WPC practices associated with each construction phase
3. Identify soil stabilization and sediment control practices for disturbed soil areas

Construction Site Monitoring Program (CSMP)

General

The QSD must prepare a CSMP as part of the SWPPP. The CSMP must be developed before starting work and be revised to reflect current construction activities as necessary.

The CSMP must include sections for the project risk level as follows:

1. For risk level 1:
 - 1.1. Visual Monitoring
 - 1.2. SAP for Non-Visible Pollutants
2. For risk level 2:
 - 2.1. Visual Monitoring
 - 2.2. SAP for Non-Visible Pollutants
 - 2.3. SAP for sediment and turbidity
 - 2.4. SAP for pH
3. For risk level 3:
 - 3.1. Visual Monitoring
 - 3.2. SAP for Non-Visible Pollutants
 - 3.3. SAP for sediment and turbidity
 - 3.4. SAP for pH
 - 3.5. SAP for receiving waters
 - 3.6. SAP for temporary active treatment systems

Visual Monitoring

The WPC Manager must oversee the performance of visual inspections for qualifying rain events. For each qualifying rain event, perform visual inspections and record observations during normal working hours as follows:

1. Record the time, date, and rain gauge reading
2. Observe:
 - 2.1. Within 2 days before the storm:
 - 2.1.1. Drainage areas for spills, leaks, or uncontrolled pollutants
 - 2.1.2. Proper implementation of WPC practices
 - 2.1.3. Storm water storage areas for leaks and adequate freeboard
 - 2.2. Every 24 hours during the storm:
 - 2.2.1. WPC practices for effective operation
 - 2.2.2. WPC practices needing maintenance and repair
 - 2.3. Within 2 days after the storm event:
 - 2.3.1. Discharge locations
 - 2.3.2. WPC practices to evaluate the design, implementation, and effectiveness
 - 2.3.3. To identify where additional WPC practices may be needed

Perform non-stormwater discharge visual inspections as follows:

1. At least once during each of the following periods:
 - 1.1. January through March

- 1.2. April through June
 - 1.3. July through September
 - 1.4. October through December
2. Observe flowing and contained storm water for the presence of floating and suspended materials, sheen on the surface, discoloration, turbidity, odors, and sources of observed pollutants
 3. Observe the job site for the presence of authorized and unauthorized non-stormwater discharges and their sources

The WPC Manager must prepare visual inspection reports that include the following:

1. Name of personnel performing the inspection, inspection date, and date inspection report completed
2. Storm and weather conditions
3. Locations and observations
4. Corrective actions taken

Maintain visual inspections reports at the job site as part of the SWPPP.

Sampling and Analysis Plan (SAP)

General

Include a SAP in the CSMP to monitor the effectiveness of WPC practices.

The SAP must comply with the Preparation Manual.

Assign trained personnel to collect water quality samples. Document their training in the SAP.

Describe the following water quality sampling procedures in the SAP:

1. Sampling equipment
2. Sample preparation
3. Collection
4. Field measurement methods
5. Analytical methods
6. Quality assurance and quality control
7. Sample preservation and labeling
8. Collection documentation
9. Sample shipping
10. Chain of custody
11. Data management and reporting
12. Precautions from the construction site health and safety plan
13. Laboratory selection and certifications

Whenever assigned field personnel take samples, comply with the equipment manufacturer's recommendation for collection, analysis methods, and equipment calibration.

Samples taken for laboratory analysis must follow water quality sampling procedures and be analyzed by a State-certified laboratory under 40 CFR Part 136, "Guidelines Establishing Test Procedures for the Analysis of Pollutants."

The SAP must identify the State-certified laboratory, sample containers, preservation requirements, holding times, and analysis method. For a list of State-certified laboratories, go to:

<http://www.cdph.ca.gov/certlic/labs/Pages/ELAP.aspx>

Include procedure for sample collection during precipitation.

Retain water quality sampling documentation and analytical results with the SWPPP at the job site.

Show pollutant sampling locations on SWPPP drawings.

If discharges or sampling locations change because of changed work activities or knowledge of site conditions, amend the SAP.

If the project is risk level 2 or risk level 3, include procedures for collecting and analyzing at least 3 samples for each day of each qualifying rain event. Describe the collection of effluent samples at all locations where the storm water is discharged off-site.

Analytical Results and Evaluation

Submit an electronic copy (in file format .xls, .txt, .csv, .dbs, or .mdb) and a printed copy of water quality analytical results, and quality assurance and quality control within 48 hours of field analysis sampling, and within 30 days for laboratory analysis. Also provide an evaluation of whether the downstream samples show levels of the tested parameter that are higher than the control sample.

Electronic water quality analysis results must have the following information:

1. Sample identification number
2. Contract number
3. Constituent
4. Reported value
5. Analytical method
6. Method detection limit
7. Reported limit

SAP for Non-Visible Pollutants

The SAP must include a description of the sampling and analysis strategy for monitoring non-visible pollutants.

The SAP must identify potential non-visible pollutants present at the job site associated with any of the following:

1. Construction materials and waste
2. Existing contamination due to historical site usage
3. Application of soil amendments, including soil stabilization materials, with the potential to change pH or contribute toxic pollutants to storm water

SWPPP drawings must show the locations planned for storage and use of potential non-visible pollutants.

The SAP must include sampling procedures for the following conditions when observed during a storm water visual inspection. For each of the following, collect at least one sample for each qualifying storm event:

1. Materials or waste containing potential non-visible pollutants that are not stored under watertight conditions

2. Materials or waste containing potential non-visible pollutants that are stored under watertight conditions, but a breach, leakage, malfunction, or spill is observed; the leak or spill has not been cleaned up before precipitation; and material or waste could discharge non-visible pollutants to surface waters or drainage system
3. Chemical applications, including fertilizer, pesticide, herbicide, methyl methacrylate concrete sealant, or non-pigmented curing compound used during precipitation or within 24 hours preceding precipitation, and could discharge pollutants to surface waters or drainage system
4. Applied soil amendments, including soil stabilization materials that could change pH levels or contribute toxic pollutants to storm water runoff and discharge pollutants to surface waters or drainage system, unless available independent test data indicates acceptable concentrations of non-visible pollutants in the soil amendment
5. Storm water runoff from an area contaminated by historical usage of the site that could discharge pollutants to surface waters or drainage systems

The SAP must provide sampling procedures and schedule for:

1. Sample collection during the first 2 hours of each rain event that generate runoff
2. Sample collection during normal working hours
3. Each non-visible pollutant source
4. Uncontaminated control sample

The SAP must identify locations for sampling downstream and control samples, and reasons for selecting those locations. Select control sample locations where the sample will not come in contact with materials, waste, or areas associated with potential non-visible pollutants or disturbed soil areas.

SAP for Sediment and Turbidity

If the project is risk level 2 or risk level 3, sample and analyze for turbidity:

Parameter	Test Method	Detection Limit (Min)	Unit
Turbidity	Field test with calibrated portable instrument	1	NTU

If the project is risk level 3 and the turbidity NEL has been exceeded, sample and analyze for SSC:

Parameter	Test Method	Detection Limit (Min)	Unit
SSC	ASTM Method D3977-97	5	Mg/L

SAP for pH

If the project is risk level 2 or risk level 3, sample and analyze for pH:

Parameter	Test Method	Detection Limit (Min)	Unit
pH	Field test with calibrated portable instrument	0.2	pH units

SAP for Receiving Waters

If the project is risk level 3, describe procedures for obtaining samples from representative and accessible locations:

1. Upstream of the discharge point
2. Downstream of the discharge point

Show receiving water sampling locations on SWPPP drawings.

If there are several discharge points, describe procedures for obtaining samples from a single upstream and a single downstream location.

Rain Event Action Plan (REAP)

REAP work includes preparing and submitting REAP forms and monitoring weather forecasts. The WPC Manager must submit a REAP to protect the job site at least 48 hours before a predicted rain event. Prepare a REAP when the National Weather Service is predicting at least a 50 percent probability of precipitation within 72 hours.

For the REAP, use approved forms and include:

1. Site location
2. Risk level
3. Contact information including 24-hour emergency phone numbers for:
 - 3.1. WPC Manager
 - 3.2. Erosion and sediment control providers or subcontractors
 - 3.3. Storm water sampling providers or subcontractors
4. Storm Information
5. Construction phase information for:
 - 5.1. Highway Construction including active and inactive areas for work activities for building roads and structures
 - 5.2. Plant Establishment including maintenance on vegetation installed for final stabilization where areas are inactive
 - 5.3. Suspension where work activities are suspended and areas are inactive
6. Construction phase information including:
 - 6.1. Construction activities
 - 6.2. Subcontractors and trades on the job site
 - 6.3. Pre-storm activities including:
 - 6.3.1. Responsibilities of the WPC Manager
 - 6.3.2. Responsibilities of the crew and crew size
 - 6.3.3. Stabilization for active and inactive disturbed soil areas
 - 6.3.4. Stockpile management
 - 6.3.5. Corrective actions taken for deficiencies identified during pre-storm visual inspection

6.4. Activities to be performed during storm events including:

- 6.4.1. Responsibilities of the WPC Manager
- 6.4.2. Responsibilities of the crew and crew size
- 6.4.3. BMP maintenance and repair

6.5. Description of flood contingency measures

You must have the REAP onsite at least 24 hours before a predicted rain event. A printed copy of each REAP must be at the job site as part of the SWPPP.

Implement the REAP including mobilizing crews to complete activities no later than 24 hours before precipitation occurs.

IMPLEMENTATION REQUIREMENTS

SWPPP Implementation

Obtain, install, and maintain a rain gauge at the job site. Observe and record daily precipitation. Monitor the National Weather Service Forecast Office on a daily basis. For forecasts, go to:

<http://www.srh.noaa.gov/forecast>

Whenever you or the Engineer identifies a deficiency in the implementation of the accepted SWPPP:

1. Correct the deficiency immediately, unless the Engineer agrees to a later date for making the correction
2. Correct the deficiency before precipitation occurs

If the Engineer determines that resources sufficient to bring the Contractor into compliance with this section "Water Pollution Control" have not been allocated, the Engineer may redirect any and all of Contractor's resources available at the project site toward this effort. In the event that the Engineer redirects resources due to Contractor's non-compliance with the provisions of this section, "Water Pollution Control", the County will not be responsible for any delays to the Contractor's schedule resulting from the reallocation, and no compensation shall made therefor.

Continue SWPPP implementation during any temporary suspension of work activities. Install WPC practices within 15 days or before predicted precipitation, whichever occurs first.

Numeric Action Levels (NALs)

If the project is risk level 2 or risk level 3, then it is subject to NALs:

Parameter	Test Method	Detection Limit (Min)	Unit	Numeric Action Level
pH	Field test with calibrated portable instrument	0.2	pH units	Lower NAL = 6.5 Upper NAL = 8.5
Turbidity	Field test with calibrated portable instrument	1	NTU	250 NTU

Numeric Effluent Limits (NELs)

If the project is risk level 3, then it is subject to NELs:

Parameter	Test Method	Detection Limit (Min)	Unit	Numeric Effluent Limit
pH	Field test with calibrated portable instrument	0.2	pH units	Lower NEL = 6.0 Upper NEL = 9.0
Turbidity	Field test with calibrated portable instrument	1	NTU	500 NTU

The storm event daily average for storms up to the 5-year, 24-hour storm, must not exceed the NEL for turbidity.

The daily average sampling results must not exceed the NEL for pH.

Storm Water Sampling and Analysis Day

Storm Water Sampling and Analysis Day work includes preparation, collection, analysis, and reporting of storm water samples for turbidity, pH, and other constituents. If the project is risk level 2 or risk level 3, and there is a qualified rain event that produces runoff, comply with the project's SAP for preparation, collection, analysis, and reporting of storm water samples. Collect:

1. Samples for each non-visible pollutant source and a corresponding uncontaminated control sample
2. Samples for turbidity, pH, and other constituents as specified
3. At least 3 samples for each day of each qualifying rain event
4. Samples for all locations where the storm water is discharged off-site

Perform sample collection during:

1. First 2 hours of each qualified rain event that produces runoff
2. Normal working hours

If the project is risk level 3, obtain receiving water samples.

You are not required to physically collect samples during dangerous weather conditions such as flooding or electrical storms.

If downstream samples show increased levels, assess WPC practices, site conditions, and surrounding influences to determine the probable cause for the increase.

Inspection

The WPC Manager must oversee inspections for WPC practices identified in the SWPPP:

1. Before a forecasted storm
2. After precipitation that causes site runoff
3. At 24-hour intervals during extended precipitation
4. On a predetermined schedule, a minimum of once a week

The WPC Manager must oversee daily inspections of:

1. Storage areas for hazardous materials and waste
2. Hazardous waste disposal and transporting activities
3. Hazardous material delivery and storage activities
4. WPC practices specified under "Construction Site Management" of these special provisions

The WPC Manager must use the Storm Water Site Inspection Report provided in the Preparation Manual. The WPC Manager must prepare BMP status reports that include the following:

1. Location and quantity of installed WPC practices
2. Location and quantity of disturbed soil for the active or inactive areas

Within 24 hours of finishing the weekly inspection, the WPC Manager must submit:

1. Copy of the completed site inspection report
2. Copy of the BMP status report

REPORTING REQUIREMENTS

Storm Water Annual Report

Storm Water Annual Report work includes certifications, monitoring and inspection results, and obtaining Storm Water Annual Report acceptance. The WPC Manager must prepare a Storm Water Annual Report. The report must:

1. Use an approved report format
2. Include project information including description and location
3. Include storm water monitoring information including:
 - 3.1. Summary and evaluation of sampling and analysis results including laboratory reports
 - 3.2. Analytical methods, reporting units, detections limits for analytical parameters
 - 3.3. Summary of corrective actions
 - 3.4. Identification of corrective actions or compliance activities that were not implemented
 - 3.5. Summary of violations
 - 3.6. Names of individuals performing storm water inspections and sampling
 - 3.7. Logistical information for inspections and sampling including location, date, time, and precipitation
 - 3.8. Visual observations and sample collection records
4. Include documentation on training for:
 - 4.1. Individuals responsible for NPDES permit compliance
 - 4.2. Individuals responsible for BMP installation, inspection, maintenance, and repair
 - 4.3. Individuals responsible for preparing, revising, and amending the SWPPP

NAL Exceedance Report

If the project is risk level 2 or risk level 3 and an effluent sample exceeds a NAL, notify the Engineer and submit a NAL Exceedance Report no later than 48 hours after the conclusion of the storm event. The report must:

1. Include the following field sampling results and inspections:

- 1.1. Analytical methods, reporting units, and detection limits
 - 1.2. Date, location, time of sampling, visual observation and measurements
 - 1.3. Quantity of precipitation of the storm event
2. Description of BMPs and corrective actions taken to manage NAL exceedance

NEL Violation Report

If the project is risk level 3 and an NEL is exceeded, notify the Engineer and submit a NEL Violation Report within 6 hours. The report must:

1. Include the following field sampling results and inspections:
 - 1.1. Analytical methods, reporting units, and detection limits
 - 1.2. Date, location, time of sampling, visual observations and measurements
 - 1.3. Quantity of precipitation of the storm event
2. Description of BMPs and corrective actions taken to manage NEL exceedance

If the project is risk level 2 or risk level 3, submit all sampling results to the Engineer no later than 48 hours after the conclusion of a storm event.

PAYMENT

The contract lump sum price paid for prepare storm water pollution prevention plan includes full compensation for furnishing all labor, materials, tools, equipment, and incidentals and for doing all the work involved in preparing, obtaining acceptance of, and amending the SWPPP and CSMP, inspecting water pollution control practices, as specified in the Standard Specifications and these special provisions, and as directed by the Engineer.

For projects with 60 working days or less, payments for SWPPP are made as follows:

1. After the Engineer accepts the SWPPP, the Department includes up to 75 percent of the bid item price in the monthly progress estimate
2. After contract acceptance, the Department pays for the remaining percentage of the bid item price

For projects with more than 60 working days, payments for SWPPP are made as follows:

1. After the Engineer accepts the SWPPP, the Department includes up to 50 percent of the bid item price in the monthly progress estimate
2. The Department pays 40 percent of the bid item price over the life of the contract
3. After contract acceptance, the Department pays for the remaining 10 percent of the bid item

If risk level 2 or 3, the Department pays \$500 for each Rain Event Action Plan submitted. The contract unit price paid for Rain Event Action Plan includes full compensation for furnishing all labor, materials, tools, equipment, and incidentals and for doing all the work involved in preparation and submittal of REAP forms, and monitoring weather forecasts as specified in the Standard Specifications and these special provisions, and as directed by the Engineer.

The Department does not adjust payment for an increase or decrease in the quantity of rain event action plans submitted. Section 4-1.03B, "Increased or Decreased Quantities," of the Standard Specifications does not apply.

The Department pays \$2,000 via agreed unit price Contract Change Order for each Storm Water Annual Report submitted. The agreed unit price Contract Change Order paid for Storm Water Annual Report includes full compensation for furnishing all labor, materials, tools, equipment, and incidentals and for doing all the work involved in preparation and submittal of Storm Water Annual Report as specified in the Standard Specifications and these special provisions, and as directed by the Engineer.

The Department does not adjust payment for an increase or decrease in the quantity of storm water annual reports submitted. Section 4-1.03B, "Increased or Decreased Quantities," of the Standard Specifications does not apply.

The work to complete the final Storm Water Annual Report contract item is excluded from Section 7-1.17, "Acceptance of Contract," of the Standard Specifications.

If risk level 2 or 3, the contract unit price paid for storm water sampling and analysis day includes full compensation for furnishing all labor, materials, tools, equipment, and incidentals and for doing all the work involved in preparation, collection, analysis, and reporting of storm water samples per qualifying rain event as specified in the Standard Specifications and these special provisions, and as directed by the Engineer.

The Department does not adjust payment for an increase or decrease in the quantity of storm water sampling and analysis day. Section 4-1.03B, "Increased or Decreased Quantities," of the Standard Specifications does not apply.

You may request or the Engineer may order laboratory analysis of storm water samples. Laboratory analysis of storm water samples will be paid for as extra work under Section 4-1.03D, "Extra Work," of the Standard Specifications.

The Department does not pay for the preparation, collection, laboratory analysis, and reporting of storm water samples for non-visible pollutants if WPC practices are not implemented before precipitation or if a failure of a WPC practice is not corrected before precipitation.

The Department does not pay for implementation of WPC practices in areas outside the highway right-of-way not specifically provided for in the drawings or in the special provisions.

The Department does not pay for WPC practices installed at your construction support facilities. WPC practices for which there are separate bid items of work are measured and paid for as those bid items of work.

For each failure to submit a completed Storm Water Annual Report, the Department withholds \$10,000. This withhold is in addition to other withholds under Section 9-1.053 "Performance Failure Withholds," of the Standard Specifications.

Each failure to comply with any part of these special provisions and each failure to implement water pollution control practices are considered separate performance failures.

10-1.51 CONSTRUCTION SITE MANAGEMENT

GENERAL

Summary

This work includes controlling potential sources of water pollution before they come in contact with storm water systems or watercourses.

Control material pollution and manage waste and non-stormwater at the job site by implementing effective handling, storage, use, and disposal practices.

For information on documents specified in these special provisions, refer to Caltrans Preparation Manual, Dewatering Guide, and BMP Manual.

Preparation Manual, Dewatering Guide, and BMP Manual are available from the Caltrans Construction Storm Water and Water Pollution Control web site at:

<http://www.dot.ca.gov/hq/construc/stormwater/stormwater1.htm>

Definitions and Abbreviations

active and inactive areas: (1) Active areas have soil disturbing work activities occurring at least once within 14 days, and (2) Inactive areas are areas that have not been disturbed for at least 15 days.

BMP Manual: The Caltrans Construction Site Best Management Practices (BMP) Manual.

CDPH: California Department of Public Health

Dewatering Guide: The Caltrans Field Guide to Construction Site Dewatering.

ELAP: Environmental Laboratory Accreditation Program

minor spills: Small quantities of oil, gasoline, paint, or other material that are small enough to be controlled by a first responder upon discovery of the spill.

MSDS: Material Safety Data Sheet

Preparation Manual: The Caltrans Storm Water Pollution Prevention Plan (SWPPP) and Water Pollution Control Program (WPCP) Preparation Manual.

semi-significant spills: Spills that can be controlled by a first responder with help from other personnel.

significant or hazardous spills: Spills that cannot be controlled by construction personnel.

WPC: Water Pollution Control

WPC Manager: Water Pollution Control Manager as defined under "Water Pollution Control" of these special provisions.

Submittals

Submit the following:

1. MSDS at least 5 days before material is used or stored
2. Monthly inventory records for material used or stored
3. Copy of written approval to discharge into a sanitary sewer system at least 5 days before beginning discharge activities

CONSTRUCTION

Spill Prevention and Control

Implement spill and leak prevention procedures for chemicals and hazardous substances stored at the job site. If you spill or leak chemicals or hazardous substances at the job site, you are responsible for all associated cleanup costs and related liability.

As soon as it is safe, contain and clean up spills of petroleum products, sanitary and septic waste substances listed under CFR Title 40, Parts 110, 117, and 302.

Minor Spills

Clean up minor spills using the following procedures:

1. Contain the spread of the spill
2. Recover the spilled material by absorption
3. Clean the contaminated area
4. Dispose of the contaminated material promptly and properly

Semi-significant Spills

Clean up semi-significant spills immediately by the following procedures:

1. Contain the spread of the spill
2. Recover the spilled material using absorption whenever a spill occurs on a paved surface or an impermeable surface
3. Contain the spill with an earthen dike and dig up the contaminated soil for disposal whenever a spill occurs on soil
4. If the spill occurs during precipitation, cover the spill with plastic or other material to prevent contaminated runoff
5. Dispose of the contaminated material promptly and properly

Significant or Hazardous Spills

Immediately notify qualified personnel of significant or hazardous spills. Do not let construction personnel attempt to clean up the spill until qualified staff have arrived. Do the following:

1. Notify the Engineer and follow up with a written report
2. Obtain the services of a spills contractor or hazardous material team immediately
3. Notify the local emergency response team by dialing 911 and county officials at the emergency phone numbers kept at the job site
4. Notify the Governor's Office of Emergency Services Warning Center at (805) 852-7550
5. Notify the National Response Center at (800) 424-8802 regarding spills of Federal reportable quantities under CFR Title 40, Parts 110, 119, and 302
6. Notify other agencies as appropriate, including:
 - 6.1. Fire Department
 - 6.2. Public Works Department
 - 6.3. Coast Guard
 - 6.4. Highway Patrol
 - 6.5. City Police or County Sheriff Department
 - 6.6. Department of Toxic Substances
 - 6.7. California Division of Oil and Gas
 - 6.8. Cal OSHA
 - 6.9. Regional Water Resources Control Board

Report minor, semi-significant, and significant spills to the WPC Manager. The WPC Manager must notify the Engineer immediately. The WPC Manager must oversee and enforce proper spill prevention and control measures.

Prevent spills from entering storm water runoff before and during cleanup. Do not bury spills or wash spills with water.

Keep material or waste storage areas clean, well organized, and equipped with enough cleanup supplies for the material being stored.

Material Management

General

Material must be delivered, used, and stored for this job in a way that minimizes or eliminates discharge of material into the air, storm drain systems, and watercourses.

Implement the practices described under "Material Management" of these special provisions while taking delivery of, using, or storing any of the following materials:

1. Hazardous chemicals including acids, lime, glues, adhesives, paints, solvents, and curing compounds
2. Soil stabilizers and binders
3. Fertilizers
4. Detergents
5. Plaster
6. Petroleum materials including fuel, oil, and grease
7. Asphalt components and concrete components
8. Pesticides and herbicides

Employees trained in emergency spill cleanup procedures must be present during the unloading of hazardous materials or chemicals.

If practicable, use less hazardous materials.

Material Storage

Use the following material storage procedures:

1. Store liquids, petroleum materials, and substances listed in CFR Title 40, Parts 110, 117, and 302 as specified by the Department, and place them in secondary containment facilities.
2. Secondary containment facilities must be impervious to the materials stored there for a minimum contact time of 72 hours.
3. Cover secondary containment facilities during non-working days and when precipitation is predicted. Secondary containment facilities must be adequately ventilated.
4. Keep secondary containment facility free of accumulated rainwater or spills. After precipitation, or in the event of spills or leaks, collect accumulated liquid and place into drums within 24 hours. Handle these liquids as hazardous waste under "Hazardous Waste" of these special provisions unless testing determines them to be nonhazardous.
5. Do not store incompatible materials, such as chlorine and ammonia, in the same secondary containment facility.
6. Store materials in the original containers with the original material labels maintained in legible condition. Replace damaged or illegible labels immediately.
7. Secondary containment facilities must have the capacity to contain precipitation from a 24-hour-long, 25-year storm, and 10 percent of the aggregate volume of all containers, or entire volume of the largest container within the facility, whichever is greater.
8. Store bagged or boxed material on pallets. Protect bagged or boxed material from wind and rain during non-working days and while precipitation is predicted.

9. Provide sufficient separation between stored containers to allow for spill cleanup or emergency response access. Storage areas must be kept clean, well organized, and equipped with cleanup supplies appropriate for the materials being stored.
10. Repair or replace perimeter controls, containment structures, covers, and liners as necessary. Inspect storage areas before and after precipitation, and at least weekly during other times.

Stockpile Management

Use the following stockpile management procedures:

1. Reduce or eliminate potential water pollution from stockpiled material including soil, paving material, and pressure treated wood.
2. Locate stockpiles:
 - 2.1. If within the floodplain, at least 100 feet from concentrated flows of storm water, drainage courses, and inlets unless approved
 - 2.2. If outside the floodplain, at least 50 feet from concentrated flows of storm water, drainage courses, and inlets unless approved

Install WPC practices within 15 days or before predicted precipitation, whichever occurs first.

Active and inactive soil stockpiles must be:

1. Covered with soil stabilization measures, plastic sheeting, or geosynthetic fabric
2. Surrounded with a linear sediment barrier

Portland cement concrete rubble, AC, HMA, AC and HMA rubble, aggregate base or aggregate sub-base stockpiles must be:

1. Covered with plastic sheeting, or geosynthetic fabric
2. Surrounded with a linear sediment barrier

Pressure treated wood stockpiles must be:

1. Placed on pallets
2. Covered with impermeable material

Cold mix asphalt concrete stockpiles must be:

1. Placed on impervious surface
2. Covered with impermeable material
3. Protected from run-on and runoff

Control wind erosion year round under Section 10, "Dust Control" of the Standard Specifications. Repair or replace linear sediment barriers and covers as needed to keep them functioning properly. If sediment accumulates to 1/3 of the linear sediment barrier height, remove the sediment.

Waste Management

Solid Waste

Do not allow litter or debris to accumulate anywhere at the job site, including storm drain grates, trash racks, and ditch lines. Pick up and remove trash and debris from the job site at least once a week. The WPC Manager must monitor solid waste storage and disposal procedures at the job site.

If practicable, recycle nonhazardous job site waste and excess material. If recycling is not practicable, disposal must comply with Section 7-1.13, "Disposal of Material Outside the Highway Right of Way" of the Standard Specifications.

Furnish enough closed-lid dumpsters of sufficient size to contain any solid waste generated by work activities. When the refuse reaches the fill line, empty the dumpsters. Dumpsters must be watertight. Do not wash out dumpsters at the job site. Furnish additional containers and pick up dumpsters more frequent during the demolition phase of construction.

Solid waste includes:

1. Brick
2. Mortar
3. Timber
4. Metal scraps
5. Sawdust
6. Pipe
7. Electrical cuttings
8. Non-hazardous equipment parts
9. Styrofoam and other packaging materials
10. Vegetative material and plant containers from highway planting
11. Litter and smoking material, including litter generated randomly by the public
12. Other trash and debris

Furnish and use trash receptacles at the job site yard, field trailers, and locations where workers gather for lunch and breaks.

Hazardous Waste

Use hazardous waste management practices if waste is generated at the job site from the following substances:

1. Petroleum products
2. Asphalt products
3. Concrete curing compound
4. Pesticides
5. Acids
6. Paints
7. Stains
8. Solvents
9. Wood preservatives and treated posts
10. Roofing tar
11. Road flares
12. Lime
13. Glues and adhesives
14. Materials classified as hazardous by California Code of Regulations, Title 22, Division 4.5; or listed in CFR Title 40, Parts 110, 117, 261, or 302

The WPC Manager must oversee and enforce hazardous waste management practices. Minimize the production of hazardous materials and hazardous waste at the job site. If damaged, repair or replace perimeter controls, containment structures, and covers.

If hazardous material levels are unknown, use a laboratory certified by ELAP under CDPH to sample and test waste to determine safe methods for storage and disposal.

Separate potentially hazardous waste from nonhazardous waste at the job site. Hazardous waste must be handled, stored, and disposed of under California Code of Regulations, Title 22, Division 4.5, Section 66262.34; and in CFR Title 49, Parts 261, 262, and 263.

Store hazardous waste in sealed containers constructed and labeled with the contents and date accumulated under California Code of Regulations, Title 22, Division 4.5; and in CFR Title 49, Parts 172, 173, 178, and 179. Keep hazardous waste containers in temporary containment facilities under "Material Storage" of these special provisions.

Furnish containers with adequate storage volume at convenient locations for hazardous waste collection. Do not overfill hazardous waste containers. Do not mix hazardous waste. Do not allow potentially hazardous waste to accumulate on the ground. Store containers of dry waste that are not watertight on pallets. Store hazardous waste away from storm drains, watercourses, moving vehicles, and equipment.

Clean water based or oil based paint from brushes or equipment within a contained area and in a way that does not contaminate soil, watercourses, and storm drain systems. Handle and dispose of the following as hazardous waste: paints, thinners, solvents, residues, and sludges that cannot be recycled or reused. When thoroughly dry, dispose of the following as solid waste: dry, latex paint and paint cans, used brushes, rags, absorbent materials, and drop cloths.

Dispose of hazardous waste within 90 days of being generated. Use a licensed hazardous waste transporter to take hazardous waste to a Class I Disposal Site. Submit a copy of uniform hazardous waste manifest forms within 24 hours of transporting hazardous waste.

The WPC Manager must inspect the following daily:

1. Storage areas for hazardous materials and waste
2. Hazardous waste disposal and transporting activities
3. Hazardous material delivery and storage activities

Contaminated Soil

Identify contaminated soil from spills or leaks by noticing discoloration, odors, or differences in soil properties. Soil with evidence of contamination must be sampled and tested by a laboratory certified by ELAP.

If levels of contamination are found to be hazardous, handle and dispose of the soil as hazardous waste. Prevent the flow of water, including ground water, from mixing with contaminated soil by using one or a combination of the following measures:

1. Berms
2. Cofferdams
3. Grout curtains
4. Freeze walls
5. Concrete seal course

If water mixes with contaminated soil and becomes contaminated, sample and test the water using a laboratory certified by ELAP. If levels of contamination are found to be hazardous, handle and dispose of the water as hazardous waste.

Concrete Waste

Use practices that will prevent the discharge of portland cement concrete, AC, or HMA waste into storm drain systems or watercourses.

Collect and dispose of portland cement concrete, AC, or HMA waste at locations where:

1. Concrete material, including grout, is used
2. Concrete dust and debris result from demolition
3. Sawcutting, coring, grinding, grooving, or hydro-concrete demolition of portland cement concrete, AC, or HMA creates a residue or slurry
4. Concrete truck or other concrete-coated equipment is cleaned at the job site

Sanitary and Septic Waste

Do not bury or discharge wastewater from sanitary or septic systems within Department right-of-way. The WPC Manager must inspect sanitary or septic waste storage and monitor disposal procedures at least weekly. Sanitary facilities that discharge to the sanitary sewer system must be properly connected and free from leaks. Place sanitary facilities at least 50 feet away from storm drains, watercourses, and flow lines. Obtain written approval from the local health agency, city, county, and sewer district before discharging from a sanitary or septic system directly into a sanitary sewer system, and submit a copy to the Engineer. Comply with local health agency provisions while using an on-site disposal system.

Liquid Waste

Use practices that will prevent job site liquid waste from entering storm drain systems or watercourses. Liquid waste includes the following:

1. Drilling slurries or fluids
2. Grease-free or oil-free wastewater or rinse water
3. Dredgings, including liquid waste from drainage system cleaning
4. Liquid waste running off a surface including wash or rinse water
5. Other non-stormwater liquids not covered by separate permits

Hold liquid waste in structurally sound, leak proof containers such as:

1. Roll-off bins
2. Portable tanks

Liquid waste containers must be of sufficient quantity and volume to prevent overflow, spills and leaks. Store containers:

1. At least 50 feet from moving vehicles and equipment
2. If within the floodplain, at least 100 feet from concentrated flows of storm water, drainage courses, watercourses, and storm drain inlets unless approved
3. If outside the floodplain, at least 50 feet from concentrated flows of storm water, drainage courses, watercourses, and storm drain inlets unless approved

Remove and dispose of deposited solids from sediment traps under "Solid Waste" of these special provisions unless the Engineer approves another method.

Liquid waste may require testing to determine hazardous material content before disposal.

Drilling fluids and residue must be disposed of outside the highway right-of-way.

If an approved location is available within the job site, fluids and residue exempt under California Code of Regulations, Title 23, Section 2511(g) may be dried by evaporation in a leak proof container. Dispose of remaining solid waste under "Solid Waste" of these special provisions.

Non-Storm Water Management

Water Control and Conservation

Manage water used for work activities to prevent erosion or discharge of pollutants into storm drain systems or watercourses. Obtain approval before washing anything at the job site with water that could discharge into a storm drain system or watercourse. Report discharges immediately.

If water is used at the job site, implement water conservation practices. Inspect irrigation areas. Adjust watering schedules to prevent erosion, excess watering, or runoff. Shut off water source to broken lines, sprinklers, or valves, and repair breaks within 24 hours. If possible, reuse water from waterline flushing for landscape irrigation. Sweep and vacuum paved areas; do not wash them with water.

Direct job site water runoff, including water from water line repair, to areas where it can infiltrate into the ground and not enter storm drain systems or watercourses. Do not allow spilled water to escape water truck filling areas. If possible, direct water from off-site sources around the job site. Minimize the contact of off-site water with job site water.

Illegal Connection and Discharge Detection and Reporting

Inspect the job site and the site perimeter before starting work for evidence of illegal connections, discharges, or dumping. After starting work, inspect the job site and perimeter on a daily schedule.

Whenever illegal connections, discharges, or dumping are discovered, notify the Engineer immediately. Take no further action unless ordered by the Engineer. Assume unlabeled or unidentifiable material is hazardous.

Look for the following evidence of illegal connections, discharges, or dumping:

1. Debris or trash piles
2. Staining or discoloration on pavement or soils
3. Pungent odors coming from drainage systems
4. Discoloration or oily sheen on water
5. Stains or residue in ditches, channels or drain boxes
6. Abnormal water flow during dry weather
7. Excessive sediment deposits
8. Nonstandard drainage junction structures
9. Broken concrete or other disturbances near junction structures

Vehicle and Equipment Cleaning

Limit vehicle and equipment cleaning or washing at the job site except what is necessary to control vehicle tracking or hazardous waste. Notify the Engineer before cleaning vehicles and equipment at the job site with soap, solvents, or steam. Contain and recycle or dispose of resulting waste under "Liquid Waste" or "Hazardous Waste" of these special provisions, whichever is applicable. Do not use diesel to clean vehicles or equipment, and minimize the use of solvents.

Clean or wash vehicles and equipment in a structure equipped with disposal facilities. If using a structure is not possible, clean or wash vehicles and equipment in an outside area. The outside area must be:

1. Paved with AC, HMA, or concrete paving
2. Surrounded by a containment berm
3. Equipped with a sump to collect and dispose of wash water
4. If within the floodplain, located at least 100 feet from concentrated flows of storm water, drainage courses, watercourses, and storm drain inlets unless approved

5. If outside the floodplain, located at least 50 feet from concentrated flows of storm water, drainage courses, watercourses, and storm drain inlets unless approved

When washing vehicles or equipment with water, use as little water as possible. Hoses must be equipped with a positive shutoff valve.

Discharge liquid from wash racks to a recycle system or to another approved system. Remove liquids and sediment as necessary.

The WPC Manager must inspect vehicle and equipment cleaning facilities:

1. Daily if vehicle and equipment cleaning occurs daily
2. Weekly if vehicle and equipment cleaning does not occur daily

Vehicle and Equipment Fueling and Maintenance

If practicable, perform maintenance on vehicles and equipment off the job site.

If fueling or maintenance must be done at the job site, designate a site, or sites, and obtain approval before using. Minimize mobile fueling or maintenance.

If vehicle and equipment fueling and maintenance must be done at the job site, areas for the following activities must be:

1. On level ground
2. Protected from storm water run-on
3. If within the floodplain, located at least 100 feet from concentrated flows of storm water, drainage courses, watercourses, and storm drain inlets unless approved
4. If outside the floodplain, located at least 50 feet from concentrated flows of storm water, drainage courses, watercourses, and storm drain inlets unless approved

Use containment berms or dikes around the fueling and maintenance area. Keep adequate quantities of absorbent spill cleanup material and spill kits in the fueling and maintenance area and on fueling trucks.

Dispose of spill cleanup material and kits immediately after use. Use drip pans or absorbent pads during fueling or maintenance.

Fueling or maintenance activities must not be left unattended. Fueling nozzles must be equipped with an automatic shutoff control. Vapor recovery fueling nozzles must be used where required by the Air Quality Management District. When not in use, nozzles must be secured upright. Do not top-off fuel tanks. Recycle or properly dispose of used batteries and tires.

The WPC Manager must inspect vehicle and equipment maintenance and fueling areas:

1. Daily when vehicle and equipment maintenance and fueling occurs daily
2. Weekly when vehicle and equipment maintenance and fueling does not occur daily

The WPC Manager must inspect vehicles and equipment at the job site for leaks and spills on a daily schedule. Operators must inspect vehicles and equipment each day of use.

If leaks cannot be repaired immediately, remove the vehicle or equipment from the job site.

Structure Removal Over or Adjacent to Water

Do not allow demolished material to enter storm water systems or watercourses. Use approved covers and platforms to collect debris. Use attachments on equipment to catch debris on small demolition activities.

Empty debris catching devices daily and handle debris under "Waste Management" of these special provisions.

The WPC Manager must inspect demolition sites within 50 feet of storm water systems or watercourses daily.

Paving, Sealing, Sawcutting, Grooving, and Grinding Activities

Prevent the following materials from entering storm drain systems or water courses:

1. Cementitious material
2. Asphaltic material
3. Aggregate or screenings
4. Grinding grooving, or sawcutting residue
5. Pavement chunks
6. Shoulder backing
7. Methacrylate

Cover drainage inlets and use linear sediment barriers to protect downhill watercourses until paving, sealing, sawcutting, grooving, or grinding activities are completed and excess material has been removed.

Cover drainage inlets and manholes during the application of seal coat, tack coat, slurry seal, or fog seal.

If precipitation is predicted, limit paving, sawcutting, and grinding to places where runoff can be captured.

Do not start seal coat, tack coat, slurry seal, or fog seal activities if precipitation is predicted during the application or curing period. Do not excavate material from existing roadways during precipitation.

Use a vacuum to remove slurry immediately after slurry is produced. Do not allow slurry to run onto lanes open to traffic or off the pavement.

Collect residue from portland cement concrete grinding and grooving activities with a vacuum attachment on the grinding machine. Do not leave any residue on the pavement or allow the residue to flow across the pavement.

If approved, material excavated from existing roadways may be stockpiled under "Stockpile Management" of these special provisions.

Do not coat asphalt trucks and equipment with substances that contain soap, foaming agents, or toxic chemicals.

When paving equipment is not in use, park over drip pans or plastic sheeting with absorbent material to catch drips.

Thermoplastic Striping and Pavement Markers

Thermoplastic striping and preheating equipment shutoff valves must work properly at all times. Do not preheat, transfer, or load thermoplastic within 50 feet of drainage inlets or watercourses. Do not fill a preheating container above a level that is 6 inches below the top. Truck beds must be cleaned daily of scraps or melted thermoplastic.

Do not unload, transfer, or load bituminous material for pavement markers within 50 feet of drainage inlets or watercourses. Release all pressure from a melting tank before removing the lid to fill or service. Do not fill a melting tank above a level that is 6 inches below the top.

Collect bituminous material from the roadway after marker removal.

Concrete Curing

Do not overspray chemical curing compound. Minimize the drift by spraying as close to the concrete as possible. Cover drainage inlets before applying the curing compound.

Minimize the use and discharge of water by using wet blankets or similar methods to maintain moisture while curing concrete.

Concrete Finishing

Collect and dispose of water and solid waste from high-pressure water blasting. Cover drainage inlets within 50 feet before sandblasting. Minimize drift of dust and blast material by keeping the nozzle close to the surface of the concrete. The blast residue may contain hazardous material.

Inspect concrete finishing containment structures for damage before each day of use and before predicted precipitation. Remove liquid and solid waste from containment structures after each work shift.

Sweeping

Sweeping must be done using hand or mechanical methods such as vacuuming.

Monitor paved areas and roadways within the job site for sediment and debris generating activities such as:

1. Clearing and grubbing
2. Earthwork
3. Trenching
4. Roadway structural section work
5. Vehicles entering and leaving the job site
6. Soil disturbing work
7. Work that causes offsite tracking of material

If sediment or debris is observed, perform sweeping:

1. Within:
 - 1.1. 8 hours of predicted rain
 - 1.2. 1 hour if sediment or debris is observed during activities that require sweeping
 - 1.3. 24 hours, if sediment and debris is observed during activities that do not require sweeping
2. On paved roads at job site entrances and exit locations
3. On paved areas within the job site that flow to storm drains or receiving waters

You may stockpile collected material at the job site. Remove collected material including sediment from paved shoulders, drain inlets, curbs and dikes, and other drainage areas. If stockpiled, dispose of collected material at least once per week.

You may dispose of sediment within the job site that you collected during sweeping activities. Protect disposal areas against erosion.

Remove and dispose of trash collected during sweeping under Section 7-1.13, "Disposal of Material Outside the Highway Right of Way" of the Standard Specifications.

Dewatering

Dewatering consists of discharging accumulated storm water, ground water, or surface water from excavations or temporary containment facilities.

If dewatering and discharging activities are specified under a work item such as "Temporary Active Treatment System" or "Dewatering and Discharge," perform dewatering work as specified in the section involved.

If dewatering and discharging activities are not specified under a work item and you will be performing dewatering activities, you must:

1. Submit a Dewatering and Discharge Plan under Section 5-1.02, "Plans and Working Drawings," of the Standard Specifications and "Water Pollution Control" of these special provisions at least 10 days before starting dewatering activities. The Dewatering and Discharge Plan must include:
 - 1.1. Title sheet and table of contents
 - 1.2. Description of dewatering and discharge activities detailing locations, quantity of water, equipment, and discharge points
 - 1.3. Estimated schedule for dewatering and discharge (start and end dates, intermittent or continuous)
 - 1.4. Discharge alternatives such as dust control or percolation
 - 1.5. Visual monitoring procedures with inspection log
2. Conduct dewatering activities under the Caltrans "Field Guide for Construction Dewatering."
3. Ensure that any dewatering discharge does not cause erosion, scour, or sedimentary deposits that could impact natural bedding materials.
4. Discharge the water within the project limits. Dispose of the water in the same way as specified for material in Section 7-1.13 "Disposal of Material Outside the Highway Right of Way" of the Standard Specification if it cannot be discharged within project limits due to site constraints.
5. Do not discharge storm water or non-stormwater that has an odor, discoloration other than sediment, an oily sheen, or foam on the surface. Notify the Engineer immediately upon discovering any such condition.

The WPC manager must inspect dewatering activities:

1. Daily when dewatering work occurs daily
2. Weekly when dewatering work does not occur daily

PAYMENT

Full compensation for doing all the work involved in construction site management including spill prevention and control, material management, waste management, non-stormwater management, and dewatering and identifying, sampling, testing, handling, and disposing of hazardous waste resulting from your activities, as specified in the Standard Specifications and these special provisions, and as ordered by the Engineer shall be considered as included in the prices paid for the various contract items of work and no additional compensation will be allowed therefor.

10-1.52 TEMPORARY TACKED STRAW

GENERAL

Summary

This work includes applying, maintaining, and removing temporary tacked straw. Tacked straw uses a mixture of tackifier, fiber, and water to stabilize active and nonactive disturbed soil areas.

The SWPPP must describe and include the use of temporary tacked straw as a water pollution control practice for soil stabilization.

Submittals

At least 5 business days before applying tacked straw, submit:

1. Material Safety Data Sheet for the tackifier.
2. Product label describing the tackifier as an erosion control product.
3. List of pollutant indicators and potential pollutants for the use of temporary tacked straw. Pollutant indicators are described under "Sampling and Analysis Plan for Non-Visible Pollutants" in the Preparation Manual.
4. Determination of acute and chronic toxicity for aquatic organisms conforming to EPA methods for the tackifier.
5. Composition of ingredients including chemical formulation.

Submit a Certificate of Compliance as specified in Section 6-1.07, "Certificates of Compliance" of the Standard Specifications for:

1. Tackifier
2. Fiber

Quality Control and Assurance

Retain and submit records of temporary tacked straw applications including:

1. Compliance with specified rates
2. Application area
3. Application time
4. Quantity

MATERIALS

Tackifier

The tackifier must be:

1. Nonflammable
2. Nontoxic to aquatic organisms
3. Free from growth or germination inhibiting factors
4. Either a plant-based product or a polymeric-emulsion blend

Tackifier classified as a plant-based product must be:

1. A natural high molecular weight polysaccharide
2. A high viscosity hydrocolloid that is miscible in water

3. Functional for at least 180 days
4. Labeled as either guar, psyllium, or starch

Guar must be:

1. A guar gum based product derived from the ground endosperm of the guar plant, cyanmopsis tetragonolobus
2. Treated with dispersant agents for easy mixing
3. Able to be diluted at the rate of 1 to 5 pounds per 100 gallons of water

Psyllium must be:

1. Made of the finely ground muciloid coating of plantago ovata or plantago ispaghula seeds
2. Able to dry and form a firm but rewettable membrane

Starch must be a non-ionic, water-soluble granular material derived from corn, potato, or other plant-based source.

Tackifier classified as polymeric emulsion blend must be:

1. A liquid or dry powder formulation
2. Anionic with a residual monomer content that is at most 0.05 percent by weight
3. Functional for at least 180 days
4. A prepackaged product labeled as containing one of the following as the primary active ingredient of the polymeric emulsion blend:
 - 4.1 Acrylic copolymers and polymers
 - 4.2 Polymers of methacrylates and acrylates
 - 4.3 Copolymers of sodium acrylates and acrylamides
 - 4.4 Polyacrylamide (PAM) and copolymer of acrylamide
 - 4.5 Hydrocolloid polymers

Fiber

Fiber must be wood fiber, cellulose fiber, alternate fiber, or a combination of these fibers as specified.

Fiber must be:

1. Free from lead paint, printing ink, varnish, petroleum products, seed germination inhibitors, or chlorine bleach
2. Free from synthetic or plastic materials
3. At most 7 percent ash

If wood fiber is specified, wood fiber must be:

1. Long strand, whole wood fibers, thermo-mechanically processed from clean, whole wood chips
2. Not made from sawdust, cardboard, paper, or paper byproducts
3. At least 25 percent of fibers 3/8 inch long
4. At least 40 percent held on a No. 25 sieve

If cellulose fiber is specified, cellulose fiber must be made from natural or recycled pulp fiber, such as wood chips, sawdust, newsprint, chipboard, corrugated cardboard, or a combination of these materials.

If alternate fiber is specified, alternate fiber must be:

1. Long strand, whole natural fibers made from clean straw, cotton, corn, or other natural feed stock
2. At least 25 percent of fibers 3/8 inch long
3. At least 40 percent held on a No. 25 sieve

Coloring Agent

Use a biodegradable, nontoxic coloring agent free from copper, mercury, and arsenic to ensure the tacked straw contrasts with the application area.

Straw

Straw must comply with Section 20-2.06, "Straw," of the Standard Specifications and be:

1. Rice, wheat, or barley. Wheat and barley straw must be derived from irrigated crops.
2. Free of plastic, glass, metal, rocks, and refuse or other deleterious material.

CONSTRUCTION

The quantity of tackifier in the mixture must be as recommended by the manufacturer. The ratio of water to fiber and tackifier in the mixture must be as recommended by the manufacturer. The proportions of various erosion control materials may be changed by the Engineer to meet field conditions. Apply tacked straw materials in separate applications in the following sequence:

1. Apply straw:
 - 1.1. At the rate of 2 tons per acre (slope measurement)
 - 1.2. To extend to the edge of retaining walls, dikes, paving and to within 4 feet from the flow line of paved and unpaved drainage ditches
 - 1.3. Using mechanical, pneumatic, or manual methods
2. Apply tackifier and fiber mixture:
 - 2.1. At application rate indicated:

Material	Application Rate lbs/acre
Wood Fiber	2500

- 2.2. During dry weather or at least 24 hours before predicted rain.

Do not apply tacked straw if:

1. Water is standing on or moving across the soil surface
2. Soil is frozen
3. Air temperature is below 40 °F during the tackifier curing period unless allowed by the manufacturer and approved by the Engineer

Do not over-spray tacked straw onto the traveled way, sidewalks, lined drainage channels, or existing vegetation.

Maintenance

Reapply tacked straw within 24 hours of discovering visible erosion, unless the Engineer approves a longer period.

Temporary tacked straw disturbed or displaced by the Contractor's vehicles, equipment, or operations must be reapplied at the Contractor's expense.

Cleanup, repair, removal, disposal, or replacement due to improper installation or the Contractor's negligence are not included in the cost for performing maintenance.

Removal

Remove tacked straw by mechanically blending it into the soil with track laying equipment, disking, or other approved method.

MEASUREMENT AND PAYMENT

Temporary tacked straw is measured by the square yard from measurements along the slope of the areas covered by the tacked straw.

Full compensation for furnishing all labor, materials (including straw, tackifier, and fiber), tools, equipment, and incidentals, and for doing all the work involved in applying temporary tacked straw, complete in place, including removal of tacked straw as specified in the Standard Specifications and as directed by the Engineer shall be paid for via Force Account Change Order. Payment of Subsistence and Travel allowance shall be excluded from this Force Account Change Order.

10-1.53 STREET SWEEPING
GENERAL

Summary

This work includes street sweeping.
The SWPPP must describe and include the use of street sweeping as a water pollution control practice for sediment control and tracking control.

Submittals

At least 5 business days before starting clearing and grubbing, earthwork, or other activities with the potential for tracking sediment or debris, submit:

1. Number of sweepers described in the SWPPP
2. Type of sweeper technology

Quality Control and Assurance

Retain and submit records of street sweeping including:

1. Quantity of sweeping waste disposal
2. Sweeping times and locations

CONSTRUCTION

Street Sweepers

Sweepers must use one of these technologies:

1. Mechanical sweeper followed by a vacuum-assisted sweeper
2. Vacuum-assisted dry (waterless) sweeper
3. Regenerative-air sweeper

Operation

Street sweeping must be done at:

1. Paved roads at job site entrance and exit locations
2. Paved areas within the job site that flow to storm drains or water bodies

Street sweeping must be done:

1. During clearing and grubbing activities
2. During earthwork activities
3. During trenching activities
4. During roadway structural section activities
5. When vehicles are entering and leaving the job site
6. After soil disturbing activities
7. After observing offsite tracking of material

Monitor paved areas and roadway within the jobsite. Street sweeping must be done:

1. Within 1 hour, if sediment or debris is observed during activities that require sweeping
2. Within 8 hours of predicted rain
3. Within 24 hours, if sediment or debris is observed during activities that do not require sweeping

At least 1 sweeper must be on the job site at all times when sweeping work is required. The sweeper must be in good working order.

Perform street sweeping to minimize dust. If dust generation is excessive or sediment pickup is ineffective, use water or a vacuum.

You may stockpile collected material on the jobsite according to the approved SWPPP. Dispose of collected material at least once per week.

Material collected during street sweeping must be removed and disposed of under Section 7-1.13, "Disposal of Material Outside the Highway Right of Way," of the Standard Specifications.

Your WPCM must inspect paved roads at job site access points:

1. Daily if earthwork and other sediment or debris generating activities occur daily
2. Weekly if earthwork and other sediment or debris generating activities do not occur daily
3. When the National Weather Service predicts precipitation with a probability of at least 30 percent

MEASUREMENT AND PAYMENT

Full compensation for furnishing all labor, materials, tools, equipment, and incidentals and for doing all the work involved in street sweeping, including disposal of collected material as specified in the Standard Specifications and as directed by the Engineer shall be paid for via Force Account Change Order. Payment of Subsistence and Travel allowance shall be excluded from this Force Account Change Order.

10-1.54 TEMPORARY EROSION CONTROL BLANKET
GENERAL

Summary

This work includes constructing, maintaining, and removing temporary erosion control blanket. Temporary erosion control blanket is used to cover and protect disturbed soil areas and soil from erosion by wind or water. Temporary erosion control blanket reduces channel erosion by protecting against scour created by concentrated flow.

The SWPPP must describe and include the use of temporary erosion control blanket as a water pollution control practice for soil stabilization.

Submittals

Submit a Certificate of Compliance as specified in Section 6-1.07, "Certificates of Compliance" of the Standard Specifications for erosion control blanket.

If you substitute the steel wire staple with an alternative attachment device, submit a sample of the device for approval at least 5 business days before installation.

MATERIALS

Erosion Control Blanket

Erosion control blanket must be:

1. Described as a rolled erosion control product (RECP)
2. Classified as temporary and degradable
3. Machine-made mats
4. Provided in rolled strips
5. Classified by the Erosion Control Technology Council (ECTC)

Erosion control blanket classified as temporary and degradable must be one of the following:

1. Double net excelsior blanket:
 - 1.1. Classified as ECTC Type 2D
 - 1.2. Classified as an erosion control blanket
 - 1.3. Designed to last for at least one year after installation
 - 1.4. With a Universal Soil Loss Equation (USLE) C-Factor of not more than 0.20 at a 2:1 (horizontal:vertical) slope
 - 1.5. With 80 percent of the wood excelsior fibers being 6 inches or longer
 - 1.6. Capable to withstand a maximum shear stress of 1.75 pounds per square foot under ASTM D 6460
 - 1.7. With a minimum tensile strength of 75 pounds per foot under ASTM D 5035
 - 1.8. With top and bottom surfaces covered with lightweight non-synthetic netting
2. Double net straw and coconut blanket:
 - 2.1. Classified as ECTC Type 2D
 - 2.2. Classified as an erosion control blanket
 - 2.3. Designed to last for at least one year after installation
 - 2.4. With a USLE C-Factor of not more than 0.20 at a 2:1 (horizontal:vertical) slope
 - 2.5. Comprised of 70 percent straw and 30 percent coconut fiber

- 2.6. Capable to withstand a maximum shear stress of 1.75 pounds per square foot under ASTM D 6460
 - 2.7. With a minimum tensile strength of 75 pounds per foot under ASTM D 5035
 - 2.8. With top and bottom surfaces covered with lightweight non-synthetic netting
3. Jute netting:
- 4.1. Classified as ECTC Type 3B
 - 4.2. Classified as an open weave textile and have from 14 to 20 strands per foot in each direction
 - 4.3. Designed to last for at least one year after installation
 - 4.4. With a USLE C-Factor of not more than 0.25 at a 1.5:1 (horizontal:vertical) slope
 - 4.5. Comprised of 100 percent unbleached and undyed spun yarn made of jute fiber
 - 4.6. With an average open area from 63 to 70 percent
 - 4.7. From 48 to 72 inches in width
 - 4.8. Capable to withstand a maximum shear stress of 2.0 pounds per square foot under ASTM D6460
 - 4.9. With a minimum tensile strength of 100 pounds per foot under ASTM D 5035
 - 4.10. From 0.90 to 1.20 pounds per square yard in weight
4. Coir netting:
- 4.1. Classified as ECTC Type 4
 - 4.2. Classified as an open weave textile and from 13 to 18 strands per foot in each direction
 - 4.3. Designed to last for at least three years after installation
 - 4.4. With a USLE C-Factor of not more than 0.25 at a 1:1 (horizontal:vertical) slope
 - 4.5. Comprised of 100 percent unbleached and undyed spun coir yarn made of coconut fiber
 - 4.6. With an average open area from 63 to 70 percent
 - 4.7. From 72 to 158 inches in width
 - 4.8. Capable to withstand a maximum shear stress of 2.25 pounds per square foot under ASTM D6460
 - 4.9. With a minimum tensile strength of 125 pounds per foot under ASTM D 5035
 - 4.10. From 1.20 to 1.67 pounds per square yard in weight

Staples

You may use an alternative attachment device such as a geosynthetic pins or plastic pegs to install erosion control blanket.

CONSTRUCTION

Before placing erosion control blanket, remove obstructions including rocks, clods, and debris greater than 1 inch in diameter from the ground.

If fiber rolls are to be placed in the same area as erosion control blankets, install the blankets before placing the fiber rolls.

If hydroseeding is to be done in the same area as erosion control blanket:

- 1. You must hydroseed before placing the double net excelsior or straw and coconut blankets
- 2. You may hydroseed before or after placing the jute or coir netting

If temporary erosion control blanket is installed on disturbed soil areas including embankment and excavation slopes:

1. Place the blanket loosely on the embankment or excavation slope with the longitudinal joints perpendicular to the slope contour lines
3. Place the blanket on the upper portion of the slope overlapping the blanket on the lower portion of the slope for transverse joints
4. Place the blanket on the side of the prevailing wind shall overlapping the blanket on the downwind side of the slope for longitudinal joints
2. Overlap and staple the longitudinal and transverse joints
5. Secure the ends of the blanket in key trenches

If temporary erosion control blanket is installed in area of concentrated runoff including ditches and swales:

1. Place the blanket loosely along the ditch or swale with the longitudinal edges and joints parallel to the centerline of the ditch or swale
2. Place the blanket on the upper portion of the slope overlapping the blanket on the lower portion of the slope for transverse joints
3. Secure transverse joints of blankets in intermediate joint trenches
4. Overlap and staple the longitudinal and transverse joints
5. Secure the ends of the blanket in intermediate and key trenches

MAINTENANCE

Remove sediment deposits, trash, and debris from temporary erosion control blanket as needed or when directed by the Engineer. If removed sediment is deposited within project limits, it must be stabilized and not subject to erosion by wind or water. Trash and debris must be removed and disposed of as specified in Section 7-1.13, "Disposal of Material Outside the Highway Right of Way," of the Standard Specifications. Maintain temporary erosion control blanket by:

1. Removing sediment from the surface of the blanket when it is deeper than 2 inches
2. Repairing or replacing the blanket when the area treated with temporary erosion control blanket becomes exposed or exhibits visible erosion
3. Repairing or replacing the erosion control blanket when washouts occur between joints or beneath the erosion control blanket
4. Repairing or replacing the erosion control when it becomes detached, torn, or unraveled

Repair temporary erosion control blanket within 24 hours of discovering damage unless the Engineer approves a longer period.

If your vehicles, equipment, or activities disturb or displace temporary erosion control blanket, repair erosion control blanket at your expense.

The Department does not pay maintenance costs for cleanup, repair, removal, disposal, or replacement due to improper installation or your negligence.

REMOVAL

When the Engineer determines that temporary erosion control blanket is not required, it must be removed and disposed of under Section 7-1.13, "Disposal of Material Outside the Highway Right of Way," of the Standard Specifications.

Ground disturbance, including holes and depressions, caused by the installation and removal of the temporary erosion control blanket must be backfilled and repaired under Section 15-1.02, "Preservation of Property," of the Standard Specifications.

MEASUREMENT AND PAYMENT

Temporary erosion control blanket is measured by the square yard of the actual area covered excluding overlaps.

Full compensation for furnishing all labor, materials, tools, equipment, and incidentals and for doing all the work involved in installing temporary erosion control blanket, complete in place, including trench excavation and backfill, and removal of temporary erosion control blanket as specified in the Standard Specifications and as directed by the Engineer shall be paid for via Force Account Change Order. Payment of Subsistence and Travel allowance shall be excluded from this Force Account Change Order.

10-1.55 TEMPORARY COVER
GENERAL

Summary

This work includes constructing, maintaining, and removing temporary cover. The SWPPP must describe and include the use of temporary cover as a water pollution control practice for soil stabilization and stockpile management.

Submittals

Submit a Certificate of Compliance as specified in Section 6-1.07, "Certificates of Compliance" of the Standard Specifications for:

1. Gravel-filled bag fabric
2. Temporary cover fabric

If you substitute a material in the following list, submit a sample of the alternative material for approval at least 5 business days before installation:

1. Alternative restrainer
2. Alternative linear sediment barrier

MATERIALS

Geosynthetic Fabrics

Geosynthetic fabrics must consist of one of the following:

1. Polyester
2. Polypropylene
3. Combined polyester and polypropylene

Sample under ASTM D 4354, Procedure C.

Test under ASTM D 4759. All properties are based on Minimum Average Roll Value (MARV). Identify, store, and handle under ASTM D 4873.

Protect geosynthetics from moisture, sunlight and damage during shipping and storage. Label each unit with the manufacturer's name, identifying information and product identification.

Gravel-filled bag fabric must comply with:

Specification	Requirements
Grab breaking load 1-inch grip, lb, min. in each direction	205
Apparent elongation percent, min., in each direction	50
Water Flow Rate max. average roll value, gallons per minute/square foot	80-150
Permittivity 1/sec., min	1.2
Apparent opening size max. average roll value, U.S. Standard sieve size	40-80
Ultraviolet Degradation	70

percent of original unexposed grab breaking load 500 hr, minimum	
--	--

The temporary cover fabric must be geosynthetic cover fabric, plastic sheeting, or a combination of both. Temporary cover fabric must be either:

1. Plastic sheeting consisting of a single-ply geomembrane material, 10 mils thick, that complies with ASTM D 5199
2. Geosynthetic cover fabric that complies with the following properties:

Specification	Requirements
Grab breaking load 1-inch grip, lb, min. in each direction	200
Apparent elongation percent, min., in each direction	50
Water Flow Rate max. average roll value, gallons per minute/square foot	75-120
Permittivity 1/sec., min	0.08
Apparent opening size max. average roll value, U.S. Standard sieve size	100
Ultraviolet Degradation percent of original unexposed grab breaking load 500 hr, minimum	70

Gravel

Gravel for gravel-filled bags must be:

1. From 3/8 to 3/4 inch in diameter
2. Clean and free from clay balls, organic matter, and other deleterious materials

Gravel-filled Bags

Gravel-filled bags must:

1. Be made from gravel-filled bag fabric.
2. Have inside dimensions from 24 to 32 inches in length, and from 16 to 20 inches in width.
3. Have the opening bound to retain the gravel. The opening must be sewn with yarn, bound with wire, or secured with a closure device.
4. Weigh from 30 to 50 pounds when filled with gravel.

Restrainers

Restrainers must be used to secure the cover fabric or plastic sheeting to the surface of the slope or stockpile.

Restrainers must be one of the following:

1. Made of gravel-filled bags that are roped together and spaced no more than a 6 feet apart
2. Made of wooden lath and anchor restrainers as shown on the plans and the following:
 - 2.1 Wooden lath must be 2" x 4" x 8', made from fir or pine, and comply with Section 88-2.12, "Lumber," of the Standard Specifications
 - 2.2 Anchor restrainers must be made from steel reinforcing bars and spaced no more than 4 feet apart along the wooden lath
3. An approved alternate method

Rope

Rope must be at least 3/8 inch in diameter.

Rope must be one of the following:

1. Biodegradable, such as sisal or manila
2. Nondegradable, such as polypropelene or nylon

Linear Sediment Barrier

Linear sediment barriers consist of one or more of the following:

1. Gravel bag berm
2. Earthen berm
3. Approved alternate method

CONSTRUCTION**Temporary Cover Fabric**

Install temporary cover fabric by:

1. Placing the temporary cover fabric loosely on the slope or stockpile with the longitudinal edges perpendicular to the slope contours
2. Placing the temporary cover fabric on the upper portion of the slope to overlap cover fabric on the lower portion of the slope
3. Placing the temporary cover fabric on the side of the prevailing wind to overlap the cover fabric on the downwind side of the slope
4. Anchoring the perimeter edge of the temporary cover fabric in key trenches
5. Overlapping edges of the temporary cover fabric by at least 2 feet
6. Placing restrainers at the overlap area and along the toe of the slope. Between overlaps, the restrainers must be spaced a maximum of 8 feet on center.
7. Ensuring that, if anchor restraints are used, the leg of the steel reinforcing bar pierces the temporary cover fabric and holds the wooden lath firmly against the surface of the slope or stockpile.

Linear Sediment Barrier

Protect excavation and embankment slopes with linear sediment barrier by:

1. Preventing run-on and concentrated flows from damaging the slopes
2. Placing the barrier approximately parallel to the slope contour at the toe of the slope
4. Angling the last 6 feet of the barrier up-slope

Protect stockpiles with linear sediment barrier by:

1. Preventing run-on and concentrated flows from touching the stockpiled material
2. Surrounding the stockpile with a linear sediment barrier
3. Adding more linear sediment barrier within 24 hours of adding more material to the stockpile

If earthen berms are used as a linear sediment barrier, they must be:

1. At least 8 inches high and 36 inches wide
2. Compacted by hand or mechanical method

If gravel bag berms are used as a linear sediment barrier:

1. Place gravel bags as a single layer
2. Place gravel bags end-to-end to eliminate gaps

If you need to increase the height of the gravel bag berm:

1. Increase height by adding rows of gravel-filled bags
2. Stack bags in a way that the bags in the top row overlap the joints in the lower row
3. Stabilize berm by adding rows at the bottom

If you remove the temporary cover to do other work, replace and secure temporary cover within one hour.

MAINTENANCE

Maintain temporary cover to minimize exposure of the slopes or stockpile and prevent movement of the material beyond the linear sediment barrier.

Maintain temporary cover by:

1. Relocating and securing restrainers to keep the erosion control blankets in place. Temporary cover fabric that breaks free must be immediately secured.
2. Repairing or replacing the temporary cover fabric when the area covered by temporary cover becomes exposed or exhibits visible erosion.
3. Repairing or replacing the linear sediment barrier when washouts occur between joints or beneath the linear sediment barrier.
4. Repairing or replacing the temporary cover fabric when it becomes detached, torn, or unraveled.

Repair temporary cover within 24 hours of discovering damage unless the Engineer approves a longer period.

If your vehicles, equipment, or activities disturb or displace temporary cover, repair temporary cover at your expense.

REMOVAL

When the Engineer determines that temporary cover is not required, it must be removed and disposed of under Section 7-1.13, "Disposal of Material Outside the Highway Right of Way," of the Standard Specifications.

Ground disturbance, including holes and depressions, caused by the installation and removal of the temporary cover must be backfilled and repaired under Section 15-1.02, "Preservation of Property," of the Standard Specifications.

MEASUREMENT AND PAYMENT

Temporary cover is measured by the square yard of the actual area covered excluding overlaps.

Full compensation for furnishing all labor, materials, tools, equipment, and incidentals and for doing all the work involved in installing temporary cover, complete in place, including restrainers and removal of temporary cover, as specified in the Standard Specifications and as directed by the Engineer shall be paid for via Force Account Change Order. Payment of Subsistence and Travel allowance shall be excluded from this Force Account Change Order.

10-1.56 TEMPORARY CONCRETE WASHOUT (PORTABLE)

GENERAL

Summary

This work includes removal and disposal of concrete waste by furnishing, maintaining, and removing portable temporary concrete washouts.

SWPPP must describe and include the use of a portable temporary concrete washout as a water pollution control practice for waste management and materials pollution control.

Submittals

At least 5 business days before concrete activities start, submit:

1. Name and location of off-site concrete waste disposal facility to receive concrete waste
2. Copy of permit issued by RWQCB for off-site commercial disposal facility
3. Copy of license for off-site commercial disposal facility
4. Copy of permit issued by state or local agency having jurisdiction over disposal facility if disposal site is located outside of the State of California

Quality Control and Assurance

Retain and submit records of disposed concrete waste including:

1. Weight tickets
2. Delivery and removal of temporary concrete washouts

MATERIALS

Portable Temporary Concrete Washout

Portable temporary concrete washout must:

1. Be a commercially available watertight container.
2. Have sufficient capacity to contain all liquid and concrete waste generated by washout activities without seepage or spills.
3. Have at least 55-gallon capacity.
4. Be labeled for the exclusive use as a concrete waste and washout facility. Stencil "Concrete Waste material" in 3-inch high letters on white background. Top of stenciling must be 12 inches from the top of the container.

Concrete Washout Sign

Concrete washout sign must comply with the provisions in Section 12-3.06B, "Portable Signs" of the Standard Specifications and:

1. Be approved by the Engineer
2. Consist of base, framework, and sign panel
3. Be made of plywood
4. Be minimum 2' x 4' in size
5. Read "Concrete Washout" with 3 inches high black letters on white background

CONSTRUCTION

Placement

Place portable temporary concrete washouts at job site:

1. Before concrete placement activities start
2. In the immediate area of concrete work as approved by the Engineer
3. No closer than 50 feet from storm drain inlets, open drainage facilities, ESAs, or watercourses
4. Away from construction traffic or public access areas

Install a concrete washout sign adjacent to each portable temporary concrete washout location.

Operation

Use portable temporary concrete washouts for:

1. Washout from concrete delivery trucks
2. Slurries containing portland cement concrete or hot mix asphalt from sawcutting, coring, grinding, grooving, and hydro-concrete demolition
3. Concrete waste from mortar mixing stations

Relocate portable temporary concrete washouts as needed for concrete construction work.

Replace portable temporary concrete washouts when filled to capacity. Do not fill higher than 6 inches below rim.

Your WPC manager must inspect portable temporary concrete washouts:

1. Daily if concrete work occurs daily
2. Weekly if concrete work does not occur daily

Maintenance

When relocating or transporting a portable temporary concrete washout within the job site, secure it to prevent spilling of concrete waste material. If any spilled material is observed, remove spilled material and place it into portable temporary concrete washout.

Removal

Dispose of concrete waste material at a facility specifically licensed to receive solid concrete waste, liquid concrete waste, or both. When portable temporary concrete washout is full, remove and dispose of concrete waste within 2 days.

PAYMENT

Full compensation for furnishing all labor, materials, tools, equipment, and incidentals and for doing all the work involved in furnishing, maintaining, and removing the portable temporary concrete washout, including removal and disposal of concrete waste, as specified in the Standard Specifications and as directed by the Engineer shall be paid for via Force Account Change Order. Payment of Subsistence and Travel allowance shall be excluded from this Force Account Change Order.

**10-1.57 TEMPORARY CHECK DAM
GENERAL**

Summary

This work includes constructing, maintaining, and removing temporary check dams.

The SWPPP must describe and include the use of temporary check dams as a water pollution control practice for soil stabilization in flow conveyances.

Submittals

Submit a Certificate of Compliance as specified in Section 6-1.07, "Certificates of Compliance" of the Standard Specifications for:

1. Fiber rolls
2. Gravel-filled bag fabric

MATERIALS

Fiber Rolls

Fiber rolls must:

1. Last for at least one year after installation
2. Be Type 1 or Type 2

If specified, Type 1 fiber rolls must be:

1. Made from an erosion control blanket:
 - 1.1. Classified by the Erosion Control Technology Council (ECTC) as ECTC 2D
 - 1.2. With a Universal Soil Loss Equation (USLE) C-Factor of not more than 0.20 at a 2:1 (horizontal:vertical) slope
 - 1.3. Capable to withstand a maximum shear stress of 1.75 pounds per square foot under ASTM D 6460
 - 1.4. With a minimum tensile strength of 75 pounds per foot under ASTM D 5035
 - 1.5. With top and bottom surfaces covered with lightweight non-synthetic netting
 - 1.6. Either of the following:
 - 1.6.1. Double net straw and coconut blanket with 70 percent straw and 30 percent coconut fiber
 - 1.6.2. Double net excelsior blanket with 80 percent of the wood excelsior fibers being 6 inches or longer
2. Rolled along the width
3. Secured with natural fiber twine every 6 feet and 6 inches from each end
4. Finished to be either:
 - 4.1. From 8 to 10 inches in diameter, from 10 to 20 feet long, and at least 0.5 pounds per linear foot
 - 4.2. From 10 to 12 inches in diameter, at least 10 feet long, and at least 2 pounds per linear foot

If specified, Type 2 fiber rolls must:

1. Be filled with rice or wheat straw, wood excelsior, or coconut fiber
2. Be covered with a biodegradable jute, sisal, or coir fiber netting
3. Have the netting secured tightly at each end
4. Be finished to be either:
 - 4.1. From 8 to 10 inches in diameter, from 10 to 20 feet long, and at least 1.1 pounds per linear foot
 - 4.2. From 10 to 12 inches in diameter, at least 10 feet long, and at least 3 pounds per linear foot

Wood Stakes

Wood stakes must be:

1. Untreated fir, redwood, cedar, or pine and cut from sound timber
2. Straight and free of loose or unsound knots and other defects which would render the stakes unfit for use
3. Pointed on the end to be driven into the ground

For fiber rolls, wood stakes must be at least:

1. 1" x 1" x 24" in size for Type 1 installation
2. 1" x 2" x 24" in size for Type 2 installation

Rope

For Type 2 installation, rope must:

1. Be biodegradable, such as sisal or manila
2. Have a minimum diameter of 1/4 inch

Gravel-filled Bag Fabric

Geosynthetic fabric for temporary gravel bag berm must consist of one of the following:

1. Polyester
2. Polypropylene
3. Combined polyester and polypropylene

Sample under ASTM D 4354, Procedure C.

Test under ASTM D 4759. All properties are based on Minimum Average Roll Value (MARV).

Identify, store, and handle under ASTM D 4873.

Protect geosynthetics from moisture, sunlight and damage during shipping and storage. Label each unit with the manufacturer's name, identifying information and product identification.

Gravel-filled bag fabric must comply with:

Specification	Requirements
Grab breaking load 1-inch grip, lb, min. in each direction	205
Apparent elongation percent, min., in each direction	50
Water Flow Rate max. average roll value, gallons per minute/square foot	80-150
Permittivity 1/sec., min	1.2
Apparent opening size max. average roll value, U.S. Standard sieve size	40-80
Ultraviolet Degradation percent of original unexposed grab breaking load 500 hr, minimum	70

Gravel

Gravel for gravel-filled bags must be:

1. From 3/8 to 3/4 inch in diameter
2. Clean and free from clay balls, organic matter, and other deleterious materials.

Gravel-filled Bags

Gravel-filled bags must:

1. Be made from gravel-filled bag fabric.
2. Have inside dimensions from 24 to 32 inches in length, and from 16 to 20 inches in width.
3. Have the opening bound to retain the gravel. The opening must be sewn with yarn, bound with wire, or secured with a closure device.
4. Weigh from 30 to 50 pounds when filled with gravel.

CONSTRUCTION

Before placing temporary check dam, remove obstructions including rocks, clods, and debris greater than one inch in diameter from the ground.

If check dams are to be placed in the same areas as erosion control blankets, then install the blankets before placing the check dams.

Temporary check dams must be:

1. Placed approximately perpendicular to the centerline of the ditch or drainage line
2. Installed with sufficient spillway depth to prevent flanking of concentrated flow around the ends of the check dam
3. Type 1 for lashed fiber rolls, Type 2 for gravel-filled bags, or a combination:
 - 3.1. If the ditch is lined with concrete or hot mix asphalt, use temporary check dam (Type 2)
 - 3.2. If the ditch is unlined, you may use temporary check dam (Type 1) or (Type 2)

Temporary check dam (Type 1) must be:

1. Secured with rope and notched wood stakes.
2. Installed by driving stakes into the soil until the notch is even with the top of the fiber roll.
3. Installed by lacing the rope between stakes and over the fiber roll. Knot the rope at each stake.
4. Tightened by driving the stakes further into the soil forcing the fiber roll against the surface of the ditch or drainage line.

Temporary check dam (Type 2) must be:

1. Placed as a single layer of gravel bags
2. End-to-end to eliminate gaps

If you need to increase the height of the temporary check dam (Type 2):

1. Increase height by adding rows of gravel-filled bags
2. Stack bags in a way that the bags in the top row overlap the joints in the lower row
3. Stabilize dam by adding rows of bags at the bottom

MAINTENANCE

Maintain temporary check dams to provide sediment holding capacity and to reduce concentrated flow velocities.

Remove sediment deposits, trash, and debris from temporary check dams as needed or when directed by the Engineer. If removed sediment is deposited within project limits, it must be stabilized and not subject to erosion by wind or water. Trash and debris must be removed and disposed of as specified in Section 7-1.13, "Disposal of Material Outside the Highway Right of Way," of the Standard Specifications.

Maintain temporary check dams by:

1. Removing sediment from behind the check dam when sediment is 1/3 the height of the check dam above ground
2. Repairing or adjusting the check dams when scour and other evidence of concentrated flow occur beneath the fiber roll
3. Repairing or replacing the fiber rolls or gravel-filled bags when they become split, torn, or unraveled
4. Adding stakes when the fiber rolls slump or sag
5. Replacing broken or split wood stakes

Repair temporary check dams within 24 hours of discovering damage unless the Engineer approves a longer period.

If your vehicles, equipment, or activities disturb or displace temporary check dams, repair temporary check dams at your expense.

The Department does not pay maintenance costs for cleanup, repair, removal, disposal, or replacement due to improper installation or your negligence.

REMOVAL

When the Engineer determines that temporary check dams are not required, they must be removed and disposed of under Section 7-1.13, "Disposal of Material Outside the Highway Right of Way," of the Standard Specifications.

Ground disturbance, including holes and depressions, caused by the installation and removal of the temporary check dams must be backfilled and repaired under Section 15-1.02, "Preservation of Property," of the Standard Specifications.

MEASUREMENT AND PAYMENT

Temporary check dam is measured by the linear foot along the centerline of the check dams. Where temporary fiber rolls are joined and overlapped, the overlap is measured as a single installed check dam.

Full compensation for furnishing all labor, materials, tools, equipment, and incidentals and for doing all the work involved in constructing the temporary check dams, complete in place, including removal of materials, cleanup and disposal of retained sediment and debris, and backfilling and repairing holes, depressions and other ground disturbance, as specified in the Standard Specifications and as directed by the Engineer shall be paid for via Force Account Change Order. Payment of Subsistence and Travel allowance shall be excluded from this Force Account Change Order.

10-1.58 TEMPORARY FIBER ROLL

GENERAL

Summary

This work includes constructing, maintaining, and removing temporary fiber roll.

The SWPPP must describe and include the use of temporary fiber roll as a water pollution control practice for sediment control.

Submittals

Submit a Certificate of Compliance as specified in Section 6-1.07, "Certificates of Compliance" of the Standard Specifications for fiber roll.

MATERIALS

Fiber Roll

Fiber roll must:

1. Last for at least one year after installation
2. Be Type 1 or Type 2

If specified, Type 1 fiber roll must be:

1. Made from an erosion control blanket:
 - 1.1. Classified by the Erosion Control Technology Council (ECTC) as ECTC 2D
 - 1.2. With a Universal Soil Loss Equation (USLE) C-Factor of not more than 0.20 at a 2:1 (horizontal:vertical) slope
 - 1.3. Capable to withstand a maximum shear stress of 1.75 pounds per square foot under ASTM D 6460
 - 1.4. With a minimum tensile strength of 75 pounds per foot under ASTM D 5035
 - 1.5. With top and bottom surfaces covered with lightweight non-synthetic netting
 - 1.6. That complies with one of the following:
 - 1.6.1. Double net straw and coconut blanket with 70 percent straw and 30 percent coconut fiber
 - 1.6.2. Double net excelsior blanket with 80 percent of the wood excelsior fibers being 6 inches or longer
2. Rolled along the width
3. Secured with natural fiber twine every 6 feet and 6 inches from each end
4. Finished to be either:
 - 4.1. From 8 to 10 inches in diameter, from 10 to 20 feet long, and at least 0.5 pounds per linear foot
 - 4.2. From 10 to 12 inches in diameter, at least 10 feet long, and at least 2 pounds per linear foot

If specified, Type 2 fiber roll must:

1. Be filled with rice or wheat straw, wood excelsior, or coconut fiber
2. Be covered with a biodegradable jute, sisal, or coir fiber netting
3. Have the netting secured tightly at each end
4. Be finished to be either:

- 4.1. From 8 to 10 inches in diameter, from 10 to 20 feet long, and at least 1.1 pounds per linear foot
- 4.2. From 10 to 12 inches in diameter, at least 10 feet long, and at least 3 pounds per linear foot

Wood Stakes

Wood stakes must be:

1. Untreated fir, redwood, cedar, or pine and cut from sound timber
2. Straight and free of loose or unsound knots and other defects which would render the stakes unfit for use
3. Pointed on the end to be driven into the ground

For fiber roll, wood stakes must be at least:

1. 1" x 1" x 24" in size for Type 1 installation
2. 1" x 2" x 24" in size for Type 2 installation

Rope

For Type 2 installation, rope must:

1. Be biodegradable, such as sisal or manila
2. Have a minimum diameter of 1/4 inch

CONSTRUCTION

Before placing fiber roll, remove obstructions including rocks, clods, and debris greater than one inch in diameter from the ground.

If fiber roll is to be placed in the same area as erosion control blanket, install the blanket before placing the fiber roll. For other soil stabilization practices such as hydraulic mulch or compost, place the fiber roll and then apply the soil stabilization practice.

Place fiber roll on slopes at the following spacing unless the plans show a different spacing:

1. 10 feet apart for slopes steeper than 2:1 (horizontal:vertical)
2. 15 feet apart for slopes from 2:1 to 4:1 (horizontal:vertical)
3. 20 feet apart for slopes from 4:1 to 10:1 (horizontal:vertical)
4. 50 feet apart for slopes flatter than 10:1 (horizontal:vertical)

Place fiber roll parallel to the slope contour. For any 20 foot section of fiber roll, do not allow the fiber roll to vary more than 5 percent from level.

Type 1 and Type 2 fiber roll may be installed using installation method Type 1, Type 2, or a combination:

For installation method Type 1, install fiber roll by:

1. Placing in a furrow that is from 2 to 4 inches deep
2. Securing with wood stakes every 4 feet along the length of the fiber roll
3. Securing the ends of the fiber roll by placing a stake 6 inches from the end of the roll
4. Driving the stakes into the soil so that the top of the stake is less than 2 inches above the top of the fiber roll

For installation method Type 2, install fiber roll by:

1. Securing with rope and notched wood stakes.

2. Driving stakes into the soil until the notch is even with the top of the fiber roll.
3. Lacing the rope between stakes and over the fiber roll. Knot the rope at each stake.
4. Tightening the fiber roll to the surface of the slope by driving the stakes further into the soil.

MAINTENANCE

Maintain temporary fiber roll to provide sediment holding capacity and to reduce runoff velocities. Remove sediment deposits, trash, and debris from temporary fiber roll as needed or when directed by the Engineer. If removed sediment is deposited within project limits, it must be stabilized and not subject to erosion by wind or water. Trash and debris must be removed and disposed of as specified in Section 7-1.13, "Disposal of Material Outside the Highway Right of Way," of the Standard Specifications. Maintain temporary fiber roll by:

1. Removing sediment from behind the fiber roll when sediment is 1/3 the height of the fiber roll above ground
2. Repairing or adjusting the fiber roll when rills and other evidence of concentrated runoff occur beneath the fiber roll.
3. Repairing or replacing the fiber roll when they become split, torn, or unraveled
4. Adding stakes when the fiber roll slump or sag
5. Replacing broken or split wood stakes

Repair temporary fiber roll within 24 hours of discovering damage unless the Engineer approves a longer period.

If your vehicles, equipment, or activities disturb or displace temporary fiber roll, repair temporary fiber roll at your expense.

The Department does not pay maintenance costs for cleanup, repair, removal, disposal, or replacement due to improper installation or your negligence.

REMOVAL

When the Engineer determines that temporary fiber roll is not required, they must be removed and disposed of under Section 7-1.13, "Disposal of Material Outside the Highway Right of Way," of the Standard Specifications.

Ground disturbance, including holes and depressions, caused by the installation and removal of the temporary fiber roll must be backfilled and repaired under Section 15-1.02, "Preservation of Property," of the Standard Specifications.

MEASUREMENT AND PAYMENT

Temporary fiber roll is measured by the linear foot along the centerline of the installed roll. Where temporary fiber roll is joined and overlapped, the overlap is measured as a single installed roll.

Full compensation for furnishing all labor, materials, tools, equipment, and incidentals and for doing all the work involved in constructing the temporary fiber roll, complete in place, including removal of materials, cleanup and disposal of retained sediment and debris, and backfilling and repairing holes, depressions and other ground disturbance, as specified in the Standard Specifications and as directed by the Engineer shall be paid for via Force Account Change Order. Payment of Subsistence and Travel allowance shall be excluded from this Force Account Change Order.

10-1.59 TEMPORARY SILT FENCE

GENERAL

Summary

This work includes installing, maintaining, and removing temporary silt fence.

The SWPPP must describe and include the use of temporary silt fence as a water pollution control practice for sediment control.

Submittals

Submit a Certificate of Compliance as specified in Section 6-1.07, "Certificates of Compliance" of the Standard Specifications for silt fence fabric.

MATERIALS

Silt Fence Fabric

Geosynthetic fabric for temporary silt fence must consist of one of the following:

1. Polyester
2. Polypropylene
3. Combined polyester and polypropylene

Sample under ASTM D 4354, Procedure C.

Test under ASTM D 4759. All properties must be based on Minimum Average Roll Value (MARV). Identify, store, and handle under ASTM D 4873.

Protect geosynthetics from moisture, sunlight, and damage during shipping and storage. Label each unit with the manufacturer's name, identifying information, and product identification.

Silt fence fabric must comply with:

Property	ASTM Designation	Specification	
		Woven	Non-woven
Grab breaking load 1-inch grip, lb, min. in each direction	D 4632	120	120
Apparent elongation percent, min., in each direction	D 4632	15	50
Water Flow Rate max. average roll value, gallons per minute/square foot	D 4491	10-50	100-150
Permittivity 1/sec., min.	D 4491	0.05	0.05
Apparent opening size max. average roll value, U.S. Standard sieve size	D 4751	30	30
Ultraviolet Degradation percent of original unexposed grab breaking load 500 hr, minimum	D 4595	70	

Posts

Posts must be wood or metal.

Wood posts must be:

1. Untreated fir, redwood, cedar, or pine and cut from sound timber
2. Straight and free of loose or unsound knots and other defects that would render the stakes unfit for use
3. Pointed on the end to be driven into the ground
4. At least 2" x 2" in size, and 4 feet long

Metal posts must:

1. Be made of steel.
2. Have a "U," "T," "L," or other cross sectional shape that can resist failure from lateral loads.
3. Be pointed on the end to be driven into the ground.
4. Weigh at least 0.75-pound per foot.
5. Be at least 4 feet long.
6. Have a safety cap attached to the exposed end. The safety cap must be orange or red plastic and fit snugly to the metal post.

CONSTRUCTION

Silt fence must be:

1. Constructed with silt fence fabric, posts, and fasteners
2. Prefabricated or assembled at the job site

Silt fence fabric must be attached to posts using these methods:

1. If prefabricated silt fence is used, posts must be inserted into sewn pockets
2. If assembled on the job site:
 - 2.1. If wood posts are used, fasteners must be staples or nails
 - 2.2. If steel posts are used, fasteners must be tie wires or locking plastic fasteners
 - 2.3. Spacing of the fasteners must be no more than 8 inches apart

Place silt fence approximately parallel to the slope contour. For any 50 foot section of silt fence, do not allow the elevation at the base of the fence to vary more than 1/3 of the fence height.

Install silt fence by:

1. Placing the bottom of the fabric in a trench that is 6 inches deep
2. Securing with posts placed on the downhill side of the fabric
3. Backfilling the trench with soil and hand or mechanically tamping to secure the fabric in the trench

If you reinforce the silt fence fabric with wire or plastic mesh, you may increase the post spacing to a maximum of 10 feet. The field-assembled reinforced silt fence must be able to retain saturated sediment without collapsing.

Connect silt fence sections by:

1. Joining separate sections of silt fence to form reaches that are no more than 500 feet long
2. Securing the end posts of each section by wrapping the tops of the posts with at least two wraps of 16-gage diameter tie wire

3. Ensuring that each reach is a continuous run of silt fence from end to end or from an end to an opening, including joined panels

If you mechanically push the silt fence fabric vertically through the soil, you must demonstrate that the silt fence fabric will not be damaged and will not slip out of the soil, resulting in sediment passing under the silt fence fabric.

MAINTENANCE

Maintain temporary silt fence to provide sediment holding capacity and to reduce runoff velocities. Remove sediment deposits, trash, and debris from temporary silt fence as needed or when directed by the Engineer. If removed sediment is deposited within project limits, it must be stabilized and not subject to erosion by wind or water. Trash and debris must be removed and disposed of as specified in Section 7-1.13, "Disposal of Material Outside the Highway Right of Way," of the Standard Specifications. Maintain temporary silt fence by:

1. Removing sediment from behind the silt fence when sediment is 1/3 the height of the silt fence above ground
2. Repairing or adjusting the silt fence when rills and other evidence of concentrated runoff occur beneath the silt fence fabric
3. Repairing or replacing the silt fence fabric when it become split, torn, or unraveled

Repair temporary silt fence within 24 hours of discovering damage unless the Engineer approves a longer period.

If your vehicles, equipment, or activities disturb or displace temporary silt fence, repair temporary silt fence at your expense.

The Department does not pay maintenance costs for cleanup, repair, removal, disposal, or replacement due to improper installation or your negligence.

REMOVAL

When the Engineer determines that temporary silt fence is not required, remove and dispose of fence under Section 7-1.13, "Disposal of Material Outside the Highway Right of Way," of the Standard Specifications. Ground disturbance, including holes and depressions, caused by the installation and removal of the temporary silt fence must be backfilled and repaired under Section 15-1.02, "Preservation of Property," of the Standard Specifications.

MEASUREMENT AND PAYMENT

Temporary silt fence is measured by the linear foot along the centerline of the installed fence.

Full compensation for furnishing all labor, materials, tools, equipment, and incidentals and for doing all the work involved in constructing temporary silt fence, complete in place, including removal of materials, cleanup and disposal of retained sediment and debris, and backfilling and repairing holes, depressions and other ground disturbance, as specified in the Standard Specifications and as directed by the Engineer shall be paid for via Force Account Change Order. Payment of Subsistence and Travel allowance shall be excluded from this Force Account Change Order.

10-1.60 TEMPORARY GRAVEL BAG BERM
GENERAL

Summary

This work includes constructing, maintaining, and removing temporary gravel bag berm.

The SWPPP must describe and include the use of temporary gravel bag berm as a water pollution control practice for sediment control.

Submittals

Submit a Certificate of Compliance as specified in Section 6-1.07, "Certificates of Compliance" of the Standard Specifications for gravel-filled bag fabric.

MATERIALS

Gravel-filled Bag Fabric

Geosynthetic fabric for temporary gravel bag berm must consist of one of the following:

1. Polyester
2. Polypropylene
3. Combined polyester and polypropylene

Sample under ASTM D 4354, Procedure C.

Test under ASTM D 4759. All properties must be based on Minimum Average Roll Value (MARV).

Identify, store, and handle under ASTM D 4873.

Protect geosynthetics from moisture, sunlight, and damage during shipping and storage. Label each unit with the manufacturer's name, identifying information, and product identification.

Gravel-filled bag fabric must comply with:

Specification	Requirements
Grab breaking load 1-inch grip, lb, min. in each direction	205
Apparent elongation percent, min., in each direction	50
Water Flow Rate max. average roll value, gallons per minute/square foot	80-150
Permittivity 1/sec., min	1.2
Apparent opening size max. average roll value, U.S. Standard sieve size	40-80
Ultraviolet Degradation percent of original unexposed grab breaking load 500 hr, minimum	70

Gravel

Gravel for gravel-filled bags must be:

1. From 3/8 to 3/4 inch in diameter

2. Clean and free from clay balls, organic matter, and other deleterious materials

Gravel-filled Bags

Gravel-filled bags must:

1. Be made from gravel-filled bag fabric.
2. Have inside dimensions from 24 to 32 inches in length, and from 16 to 20 inches in width.
3. Have the opening bound to retain the gravel. The opening must be sewn with yarn, bound with wire, or secured with a closure device.
4. Weigh from 30 to 50 pounds when filled with gravel.

CONSTRUCTION

Before constructing temporary gravel bag berm, remove obstructions including rocks, clods, and debris greater than 1 inch in diameter from the ground.

Temporary gravel bag berm must:

1. Be placed as a single layer of gravel bags to create a linear sediment barrier
2. Be placed end-to-end to eliminate gaps
3. Be placed approximately parallel to the slope contour
4. Have the last 6 feet of the gravel bag berm angled up-slope

If you need to increase the height of the temporary gravel bag berm:

1. Increase height by adding rows of gravel-filled bags
2. Stack bags in a way that the bags in the top row overlap the joints in the lower row
3. Stabilize berm by adding rows at the bottom

If used within shoulder area, gravel-filled bags must be placed behind temporary railing (Type K).

MAINTENANCE

Maintain temporary gravel bag berm to provide sediment holding capacity and to reduce runoff velocities. Remove sediment deposits, trash, and debris from temporary gravel bag berm as needed or when directed by the Engineer. If removed sediment is deposited within project limits, it must be stabilized and not subject to erosion by wind or water. Trash and debris must be removed and disposed of as specified in Section 7-1.13, "Disposal of Material Outside the Highway Right of Way," of the Standard Specifications. Maintain temporary gravel bag berm by:

1. Removing sediment from behind the gravel bag berm when sediment is 1/3 the height of the gravel bag berm above ground
2. Repairing or adjusting the gravel-filled bags when rills and other evidence of concentrated runoff occur beneath the gravel-filled bags
3. Repairing or replacing the gravel-filled bags when they become split, torn, or unraveled

Repair temporary gravel bag berm within 24 hours of discovering damage unless the Engineer approves a longer period.

If your vehicles, equipment, or activities disturb or displace temporary gravel bag berm, repair temporary gravel bag berm at your expense.

The Department does not pay maintenance costs for cleanup, repair, removal, disposal, or replacement due to improper installation or your negligence.

REMOVAL

When the Engineer determines that temporary gravel bag berm is not required, they must be removed and disposed of under Section 7-1.13, "Disposal of Material Outside the Highway Right of Way," of the Standard Specifications.

Ground disturbance, including holes and depressions, caused by the installation and removal of the temporary gravel bag berm must be backfilled and repaired under Section 15-1.02, "Preservation of Property," of the Standard Specifications.

MEASUREMENT AND PAYMENT

Temporary gravel bag berm is measured by the linear foot along the centerline of the installed berm.

Full compensation for furnishing all labor, materials, tools, equipment, and incidentals and for doing all the work involved in constructing the temporary gravel bag berm, complete in place, including removal of materials, cleanup and disposal of retained sediment and debris, and backfilling and repairing holes, depressions and other ground disturbance, as specified in the Standard Specifications and as directed by the Engineer shall be paid for via Force Account Change Order. Payment of Subsistence and Travel allowance shall be excluded from this Force Account Change Order.

**10-1.61 TEMPORARY CONSTRUCTION ENTRANCE
GENERAL**

Summary

This work includes constructing, maintaining, and removing temporary construction entrance to provide temporary access.

The SWPPP must describe and include the use of temporary construction entrance as a water pollution control practice for tracking control.

Temporary construction entrance must be Type 1.

Submittals

Submit a Certificate of Compliance under Section 6-1.07, "Certificates of Compliance," of the Standard Specifications for:

1. Temporary entrance fabric
2. Rock

Submit details for alternatives at least 5 business days before installation. You may propose alternatives for the following items:

1. Alternative sump
2. Alternative corrugated steel panels

If the Engineer approves, you may eliminate the sump.

MATERIALS

Temporary Entrance Fabric

Temporary entrance fabric must comply with Section 88-1.06 A "Rock Slope Protection" of the Standard Specifications and shall be Class 10.

Rock

Rock must be Type A or Type B.
Rock (Type A) must comply with:

1. Requirements under Section 72-2.02, "Materials," of the Standard Specifications
2. Following sizes:

Square Screen Size (inch)	Percentage Passing	Percentage Retained
6	100	0
3	0	100

Rock (Type B) must be Railway Ballast Number 25. Do not use blast furnace slag. Railway Ballast Number 25 must comply with:

1. Description in AREMA Manual for Railway Engineering.
2. Following sizes:

Nominal Size Square Opening	Percentage Passing								
	3"	2-1/2"	2"	1-1/2"	1"	3/4"	1/2"	3/8"	No. 4
2-1/2"-3/8"	100	80-100	60-85	50-70	25-50	-	5-20	0-10	0-3

3. Following properties:

Specification	Requirements
Percent material passing No. 200 sieve, max. ASTM: C 117	1.0
Bulk specific gravity, min. ASTM: C 127	2.60
Absorption, percent min. ASTM: C 127	1.0
Clay lumps and friable particles, percent max. ASTM: C 142	0.5
Degradation, percent max. ASTM: C 535	30
Soundness (Sodium Sulfate), percent max. ASTM: C 88	5.0
Flat, elongated particles, or both, percent max. ASTM: D 4791	5.0

Corrugated Steel Panels

Corrugated steel panels must:

1. Be made of steel.
2. Be pressed or shop welded
3. Have a slot or hook for connecting panels together

CONSTRUCTION

Prepare location for temporary construction entrance by:

1. Removing vegetation to ground level and clear away debris
2. Grading ground to uniform plane
3. Grading ground surface to drain
4. Removing sharp objects that may damage fabric
5. Compacting the top 1.5 feet of soil to at least 90 percent relative compaction

If temporary entrance (Type 1) is specified, use rock (Type A).

If temporary construction entrance (Type 2) is specified, use Rock (Type B) under corrugated steel panels.

Use at least 6 corrugated steel panels for each entrance. Couple panels together.

Install temporary construction entrance by:

1. Positioning fabric along the length of the entrance
2. Overlapping sides and ends of fabric by at least 12 inches
3. Spreading rock over fabric in the direction of traffic
4. Covering fabric with rock within 24 hours
5. Keeping a 6 inch layer of rock over fabric to prevent damage to fabric by spreading equipment

Do not drive on fabric until rock is spread.

Unless the Engineer eliminates the sump, install a sump within 20 feet of each temporary construction entrance.

Repair fabric damaged during rock spreading by placing a new fabric over the damaged area. New fabric must be large enough to cover damaged area and provide at least 18-inch overlap on all edges.

Maintenance

Maintain temporary construction entrance to minimize generation of dust and tracking of soil and sediment onto public roads. If dust or sediment tracking increases, place additional rock unless the Engineer approves another method.

Repair temporary construction entrance if:

1. Fabric is exposed
2. Depressions in the entrance surface develop
3. Rock is displaced

Repair temporary construction entrance within 24 hours of discovering damage unless the Engineer approves a longer period.

During use of temporary construction entrance, do not allow soil, sediment, or other debris tracked onto pavement to enter storm drains, open drainage facilities, or watercourses. When material is tracked onto pavement, remove it within 24 hours unless the Engineer approves a longer period.

If your vehicles, equipment, or activities disturb or displace the temporary construction entrance, repair it at your expense.

The Department does not pay maintenance costs for cleanup, repair, removal, disposal, or replacement due to improper installation or your negligence.

Removal

When the Engineer determines that temporary construction entrance is not required, remove and dispose of it under Section 7-1.13, "Disposal of Material Outside the Highway Right of Way," of the Standard Specifications.

Backfill and repair ground disturbance, including holes and depressions, caused by installation and removal of temporary construction entrance under Section 15-1.02, "Preservation of Property," of the Standard Specifications.

MEASUREMENT AND PAYMENT

Temporary construction entrance is determined from actual count in place. Temporary construction entrance is measured one time only and no additional measurement will be recognized.

Full compensation for furnishing all labor, materials, tools, equipment, and incidentals and for doing all the work involved in constructing temporary construction entrance, complete in place, including removal of temporary construction entrance, as specified in the Standard Specifications and as directed by the Engineer shall be paid for via Force Account Change Order. Payment of Subsistence and Travel allowance shall be excluded from this Force Account Change Order.

No additional compensation will be made if the temporary construction entrance is relocated during the course of construction.

10-1.62 TEMPORARY DRAINAGE INLET PROTECTION

GENERAL

Summary

This work includes constructing, maintaining, and removing temporary drainage inlet protection. Drainage inlet protection settles and filters sediment before stormwater runoff discharges into storm drainage systems.

The SWPPP must describe and include the use of temporary drainage inlet protection as a water pollution control practice for sediment control.

Provide temporary drainage inlet protection to meet the changing conditions around the drainage inlet. Temporary drainage inlet protection must be:

1. Appropriate type to meet the conditions around the drainage inlet
2. Type 1, Type 2, Type 3A, Type 3B, Type 4, Type 4B, Type 5, Type 6A, Type 6B, or a combination

Submittals

Submit a Certificate of Compliance as specified in Section 6-1.07, "Certificates of Compliance" of the Standard Specifications for:

1. Erosion control blanket
2. Fiber rolls
3. Safety cap for metal posts
4. Silt fence fabric
5. Sediment filter bag
6. Foam barrier
7. Rigid plastic barrier
8. Gravel-filled bag fabric

If you substitute the steel wire staple with an alternative attachment device, submit a sample of the device for approval at least 5 business days before installation.

MATERIALS

Geosynthetic Fabrics

Geosynthetic fabrics for temporary drainage inlet protection must consist of one of the following:

1. Polyester
2. Polypropylene
3. Combined polyester and polypropylene

Geosynthetic fabrics for temporary drainage inlet must comply with the specifications for water pollution control in Section 88-1.05, "Water Pollution Control," of the Standard Specifications. Foam barrier must comply with:

Foam Barrier

Property	ASTM Designation	Specification
Grab breaking load 1-inch grip, lb, min. in each direction	D 4632	200
Apparent elongation percent, min., in each direction	D 4632	15
Water Flow Rate max. average roll value, gallons per minute/square foot	D 4491	100-150
Permittivity 1/sec., min.	D 4491	0.05
Apparent opening size max. average roll value, U.S. Standard sieve size	D 4751	40
Ultraviolet Degradation percent of original unexposed grab breaking load 500 hr, minimum	D 4595	70

Sample under ASTM D 4354, Procedure C.

Test under ASTM D 4759. All properties are based on Minimum Average Roll Value (MARV).

Identify, store, and handle under ASTM D 4873.

Erosion Control Blanket

Erosion control blanket must be:

1. Described as a rolled erosion control product (RECP)
2. Classified as temporary and degradable
3. Machine-made mats
4. Provided in rolled strips
5. Classified by the Erosion Control Technology Council (ECTC)

Erosion control blanket classified as temporary and degradable must be one of the following:

1. Double net excelsior blanket:
 - 1.1. Classified as ECTC Type 2D
 - 1.2. Classified as an erosion control blanket
 - 1.3. Designed to last for at least one year after installation
 - 1.4. With a Universal Soil Loss Equation (USLE) C-Factor of not more than 0.20 at a 2:1 (horizontal:vertical) slope
 - 1.5. With 80 percent of the wood excelsior fibers being 6 inches or longer
 - 1.6. Capable to withstand a maximum shear stress of 1.75 pounds per square foot under ASTM D 6460
 - 1.7. With a minimum tensile strength of 75 pounds per foot under ASTM D 5035

- 1.8. With top and bottom surfaces covered with lightweight non-synthetic netting
2. Double net straw and coconut blanket:
 - 2.1. Classified as ECTC Type 2D
 - 2.2. Classified as an erosion control blanket
 - 2.3. Designed to last for at least one year after installation
 - 2.4. With a USLE C-Factor of not more than 0.20 at a 2:1 (horizontal:vertical) slope
 - 2.5. Comprised of 70 percent straw and 30 percent coconut fiber
 - 2.6. Capable to withstand a maximum shear stress of 1.75 pounds per square foot under ASTM D 6460
 - 2.7. With a minimum tensile strength of 75 pounds per foot under ASTM D 5035
 - 2.8. With top and bottom surfaces covered with lightweight non-synthetic netting
3. Jute netting:
 - 3.1. Classified as ECTC Type 3B
 - 3.2. Classified as an open weave textile and have from 14 to 20 strands per foot in each direction
 - 3.3. Designed to last for at least one year after installation
 - 3.4. With a USLE C-Factor of not more than 0.25 at a 1.5:1 (horizontal:vertical) slope
 - 3.5. Comprised of 100 percent unbleached and undyed spun yarn made of jute fiber
 - 3.6. With an average open area from 63 to 70 percent
 - 3.7. From 48 to 72 inches in width
 - 3.8. Capable to withstand a maximum shear stress of 2.0 pounds per square foot under ASTM D 6460
 - 3.9. With a minimum tensile strength of 100 pounds per foot under ASTM D 5035
 - 3.10. From 0.90 to 1.20 pounds per square yard in weight
4. Coir netting:
 - 4.1. Classified as ECTC Type 4
 - 4.2. Classified as an open weave textile and from 13 to 18 strands per foot in each direction
 - 4.3. Designed to last for at least three years after installation
 - 4.4. With a USLE C-Factor of not more than 0.25 at a 1:1 (horizontal:vertical) slope
 - 4.5. Comprised of 100 percent unbleached and undyed spun coir yarn made of coconut fiber
 - 4.6. With an average open area from 63 to 70 percent
 - 4.7. From 72 to 158 inches in width
 - 4.8. Capable to withstand a maximum shear stress of 2.25 pounds per square foot under ASTM D6460
 - 4.9. With a minimum tensile strength of 125 pounds per foot under ASTM D 5035
 - 4.10. From 1.20 to 1.67 pounds per square yard in weight

Staples

You may use an alternative attachment device such as a geosynthetic pins or plastic pegs to install erosion control blanket.

Rock

Rock must comply with:

1. Requirements under Section 72-2.02, "Materials," of the Standard Specifications
2. Following sizes:

Square Screen Size (inch)	Percentage Passing	Percentage Retained
6	100	0
3	0	100

Rope

Rope for fiber rolls must be:

1. Biodegradable, such as sisal or manila
2. At least 1/4 inch in diameter

Fiber Rolls

Fiber rolls must:

1. Last for at least one year after installation
2. Be Type 1 or Type 2

For Type 1, fiber rolls must be:

1. Made from an erosion control blanket classified as temporary and degradable
2. Rolled along the width
3. Secured with natural fiber twine every 6'-6" from each end
4. Finished to be either:
 - 4.1. From 8 to 10 inches in diameter, from 10 to 20 feet long, and at least 0.5 pounds per linear foot
 - 4.2. From 10 to 12 inches in diameter, at least 10 feet long, and at least 2 pounds per linear foot

For Type 2, fiber rolls must:

1. Be filled with rice or wheat straw, wood excelsior, or coconut fiber
2. Be covered with biodegradable jute, sisal, or coir fiber netting
3. Have netting secured tightly at each end
4. Be finished to be either:
 - 4.1. From 8 to 10 inches in diameter, from 10 to 20 feet long, and at least 1.1 pounds per linear foot
 - 4.2. From 10 to 12 inches in diameter, at least 10 feet long, and at least 3 pounds per linear foot

Wood Stakes

Wood stakes must be:

1. Untreated fir, redwood, cedar, or pine and cut from sound timber
2. Straight and free of loose or unsound knots and other defects which would render the stakes unfit for use
3. Pointed on the end to be driven into the ground

For fiber rolls, wood stakes must be at least:

1. 1" x 1" x 24" in size for Type 1 installation
2. 1" x 2" x 24" in size for Type 2 installation

Posts

Posts must be wood or metal.

Wood posts must be:

1. Untreated fir, redwood, cedar, or pine and cut from sound timber
2. Straight and free of loose or unsound knots and other defects that would render the stakes unfit for use
3. Pointed on the end to be driven into the ground
4. At least 2" x 2" in size, and 4 feet long

Metal posts must:

1. Be made of steel.
2. Have a "U," "T," "L," or other cross sectional shape that can resist failure from lateral loads.
3. Be pointed on the end to be driven into the ground.
4. Weigh at least 0.75-pound per foot.
5. Be at least 4 feet long.
6. Have a safety cap attached to the exposed end. The safety cap must be orange or red plastic and fit snugly to the metal post.

Silt Fence

Silt fence must be:

1. Constructed with silt fence fabric, posts, and fasteners
2. Prefabricated or assembled at the job site

Silt fence fabric must be attached to posts using these methods:

1. If prefabricated silt fence is used, posts must be inserted into sewn pockets
2. If assembled on the job site:
 - 2.1. If wood posts are used, fasteners must be staples or nails
 - 2.2. If steel posts are used, fasteners must be tie wires or locking plastic fasteners
 - 2.3. Spacing of the fasteners must be at least 8 inches

Gravel-filled Bags

Gravel-filled bags must:

1. Be made from fabric.
2. Have inside dimensions from 24 to 32 inches in length, and from 16 to 20 inches in width.
3. Have the opening bound to retain the gravel. The opening must be sewn with yarn, bound with wire, or secured with a closure device.
4. Weigh from 30 to 50 pounds when filled with gravel.

Gravel for gravel-filled bags must be:

1. From 3/8 to 3/4 inch in diameter
2. Clean and free from clay balls, organic matter, and other deleterious materials

Sediment Filter Bag

Sediment filter bag must:

1. Be made of fabric
2. Be sized to fit the catch basin or drainage inlet
3. Include a high-flow bypass

Sediment filter bag may include a metal frame. Sediment filter bags that do not have a metal frame and are deeper than 18 inches must:

1. Include lifting loops and dump straps
2. Include a restraint cord to keep the sides of the bag away from the walls of the catch basin

Foam Barriers

Foam barriers must:

1. Be filled with a urethane foam core
2. Have a geosynthetic fabric cover and flap
3. Have a triangular, circular, or square shaped cross section
4. Have a vertical height of at least 5 inches after installation
5. Have a horizontal flap of at least 8 inches in width
6. Have a length of at least 4 feet per unit
7. Have the ability to interlock separate units into a longer barrier so that water does not flow between the units
8. Be secured to:
 - 8.1. Pavement with 1-inch concrete nails with 1-inch washers and solvent-free adhesive
 - 8.2. Soil with 6-inch nails with 1-inch washers

Rigid Plastic Barriers

Rigid plastic barriers must:

1. Have an integrated filter
2. Have a formed outer jacket of perforated high density polyethylene (HDPE) or polyethylene terephthalate (PET)
3. Have a flattened tubular shaped cross section
4. Be made from virgin or recycled materials
5. Be free from biodegradable filler materials that degrade the physical or chemical characteristics of the finished filter core or outer jacket
6. Have a length of at least 4 feet per unit
7. Have the ability to interlock separate units into a longer barrier so that water does not flow between the units
8. Be secured to:
 - 8.1. Pavement with 1-inch concrete nails with 1-inch washers and solvent-free adhesive, with gravel-filled bags, or a combination
 - 8.2. Soil with 6-inch nails with 1-inch washers and wood stakes

9. Comply with the following properties:

Specification	Requirements
Grab tensile strength of outer jacket material, pounds/square inch, min. in each direction ASTM D 4632*	4000
Break strength of outer jacket, pounds/square inch ASTM D 4632*	1300
Permittivity of filter core, 1/sec., min. ASTM D 4491	0.38
Flow rate of filter core, gallons per minute per square foot, ASTM D 4491	100 min. 200 max.
Filter core aperture size, max., Average Opening Size (AOS), microns	425
Ultraviolet stability (outer jacket & filter core), percent tensile strength retained after 500 hours, min. ASTM D 4355 (xenon-arc lamp and water spray weathering method)	90

* or appropriate test method for specific polymer

If used at a curb inlet without a grate, rigid plastic barriers must:

1. Have a horizontal flap of at least 6 inches with an under-seal gasket to prevent underflows
2. Include a high-flow bypass
3. Have a vertical height of at least 7 inches after installation
4. Be sized to fit the catch basin or drainage inlet

If used at a grated catch basin without a curb inlet, rigid plastic barriers must:

1. Cover the grate by at least 2 inches on each side and have an under-seal gasket to prevent underflows
2. Include a high-flow bypass
3. Have a vertical height of at least 1.5 inches after installation
4. Be sized to fit the catch basin or drainage inlet

If used at a curb inlet with a grate, rigid plastic barriers must:

1. Have a horizontal flap that covers the grate by at least 2 inches on the 3 sides away from the curb opening and have an under-seal gasket to prevent underflows
2. Include a high-flow bypass
3. Have a vertical section that covers the curb opening by at least 5 inches after installation
4. Be sized to fit the catch basin or drainage inlet

If used as a linear sediment barrier, rigid plastic barriers:

1. Must have an installed height of at least 6 inches
2. May have a horizontal flap of at least 4 inches

Linear Sediment Barrier

Linear sediment barriers must consist of one or more of the following:

1. Silt fence
2. Gravel-filled bags
3. Fiber roll
4. Rigid plastic barrier

5. Foam barrier

Flexible Sediment Barrier

Flexible sediment barriers consist of one or more of the following:

1. Rigid plastic barrier
2. Foam barrier

CONSTRUCTION

For drainage inlet protection at drainage inlets in paved and unpaved areas:

1. Prevent ponded runoff from encroaching on the traveled way or overtopping the curb or dike. Use linear sediment barriers to redirect runoff and control ponding.
2. Clear the area around each drainage inlet of obstructions including rocks, clods, and debris greater than one inch in diameter before installing the drainage inlet protection.
3. Install a linear sediment barrier up-slope of the existing drainage inlet and parallel with the curb, dike, or flow line to prevent sediment from entering the drainage inlet.

Erosion Control Blanket

To install erosion control blanket :

1. Secure blanket to the surface of the excavated sediment trap with staples and embed in a trench adjacent to the drainage inlet
2. Anchor the perimeter edge of the erosion control blanket in a trench

Silt Fence

If silt fence is used as a linear sediment barrier:

1. Place fence along the perimeter of the erosion control blanket, with the posts facing the drainage inlet
2. Install fence with the bottom edge of the silt fence fabric in a trench. Backfill the trench with soil and compact manually

Gravel Bag Berm

If gravel bag berm is used as a linear sediment barrier:

1. Place gravel-filled bags end-to-end to eliminate gaps
2. Stack bags in a way that the bags in the top row overlap the joints in the lower row

If gravel bag berms are used for Type 3A and Type 3B:

1. Place gravel-filled bags end-to-end to eliminate gaps
2. Stack bags in a way that the bags in the top row overlap the joints in the lower row
3. Arrange bags to create a spillway by removing one or more gravel-filled bags from the upper layer

If used within shoulder area, place gravel-filled bags behind temporary railing (Type K).

Fiber Rolls

If fiber rolls are used as a linear sediment barrier:

1. Place fiber rolls in a furrow.

2. Secure fiber rolls with stakes installed along the length of the fiber rolls. Stakes must be installed from 6 to 12 inches from the end of the rolls.

If fiber rolls are used as a linear sediment barrier for Type 4A, place them over the erosion control blanket.

Foam Barriers

If foam barriers are used as a linear sediment barrier:

1. Install barriers with the horizontal flap in a 3 inch deep trench and secured with nails and washers placed no more than 4 feet apart
2. Secure barriers with 2 nails at the connection points where separate units overlap
3. Place barriers without nails or stakes piercing the core

Flexible Sediment Barriers

If flexible sediment barriers are used:

1. Secure barriers to the pavement with nails and adhesive, gravel-filled bags, or a combination
2. Install barriers flush against the sides of concrete, asphalt concrete, or hot mix asphalt curbs or dikes
3. Place barriers to provide a tight joint with the curb or dike and anchored in a way that runoff cannot flow behind the barrier

If flexible sediment barriers are used for Type 4B:

1. Secure barriers to the pavement according to the angle and spacing shown on the plans
2. Place barriers to provide a tight joint with the curb or dike. Cut the cover fabric or jacket to ensure a tight fit

Rigid Sediment Barriers

If rigid sediment barriers are used at a grated catch basin without a curb inlet:

1. Place barriers using the gasket to prevent runoff from flowing under the barrier
2. Secure barriers to the pavement with nails and adhesive, gravel-filled bags, or a combination

If rigid sediment barriers are used for linear sediment barriers:

1. Install barriers in a trench. Backfill the trench with soil and compact manually
2. Place barrier with separate units overlapping at least 4 inches
3. Reinforce barriers with a wood stake at each overlap
4. Fasten barriers to the wood stakes with steel screws, 16 gauge galvanized steel wire, or with UV stabilized cable ties that are from 5 to 7 inches in length

Sediment Filter Bags

Install sediment filter bags for Type 5 by:

1. Removing the drainage inlet grate
2. Placing the sediment bag in the opening
3. Replacing the grate to secure the sediment filter bag in place

MAINTENANCE

Maintain temporary drainage inlet protection to provide sediment holding capacity and to reduce runoff velocities.

Remove sediment deposits, trash, and debris from temporary drainage inlet protection as needed or when directed by the Engineer. If removed sediment is deposited within project limits, it must be stabilized and not subject to erosion by wind or water. Trash and debris must be removed and disposed of as specified in Section 7-1.13, "Disposal of Material Outside the Highway Right of Way," of the Standard Specifications. Maintain temporary drainage inlet protection by removing sediment from:

1. Behind flexible sediment barriers when sediment exceeds 1 inch in depth
2. Surface of the erosion control blanket when sediment exceeds 1 inch in depth
3. Sediment trap for Type 2 when the volume has been reduced by approximately one-half
4. Behind silt fence when the sediment is 1/3 the height of the silt fence fabric above ground
5. Sediment filter bags when filled or when the restraint cords are no longer visible

If rills and other evidence of concentrated runoff occur beneath the linear sediment barrier, repair or adjust the barrier.

If silt fence fabric becomes split, torn, or unraveled, repair or replace silt fence.

If geosynthetic fabric becomes split, torn, or unraveled, repair or replace foam barriers.

Repair or replace sagging or slumping linear sediment barriers with additional stakes. Replace broken or split wood stakes.

Reattach foam barriers and rigid plastic barriers that become detached or dislodged from the pavement.

Repair split or torn rigid plastic barriers with 16 gauge galvanized steel wire or UV stabilized cable ties that are from 5 to 7 inches in length.

For sediment filter bags without metal frames, empty by placing one inch steel reinforcing bars through the lifting loops and then lift the filled bag from the drainage inlet. For sediment filter bags with metal frames, empty by lifting the metal frame from the drainage inlet. Rinse before replacing in the drainage inlet. When rinsing the sediment filter bags, do not allow the rinse water to enter a drain inlet or waterway.

Repair temporary drainage inlet protection within 24 hours of discovering damage unless the Engineer approves a longer period.

If your vehicles, equipment, or activities disturb or displace temporary drainage inlet protection, repair temporary drainage inlet protection at your expense.

The Department does not pay maintenance costs for cleanup, repair, removal, disposal, or replacement due to improper installation or your negligence.

REMOVAL

When the Engineer determines that the temporary drainage inlet protection is not required, it must be removed and disposed of under Section 7-1.13, "Disposal of Material Outside the Highway Right of Way," of the Standard Specifications.

Ground disturbance, including holes and depressions, caused by the installation and removal of the temporary drainage inlet protection must be backfilled and repaired under Section 15-1.02, "Preservation of Property," of the Standard Specifications.

MEASUREMENT AND PAYMENT

Quantities of temporary drainage inlet protection will be determined from actual count in place. The protection will be measured one time only and no additional measurement will be recognized.

Full compensation for furnishing all labor, materials, tools, equipment, and incidentals and for doing all the work involved in constructing the temporary drainage inlet protection, complete in place, including removal of materials, cleanup and disposal of retained sediment and debris, and backfilling and repairing holes, depressions and other ground disturbance, as specified in the Standard Specifications and as directed by the Engineer shall be paid for via Force Account Change Order. Payment of Subsistence and Travel allowance shall be excluded from this Force Account Change Order.

No additional compensation will be made if the temporary drainage inlet protection is relocated during the course of construction.